

Hy-Line® VARIETY

BROWN

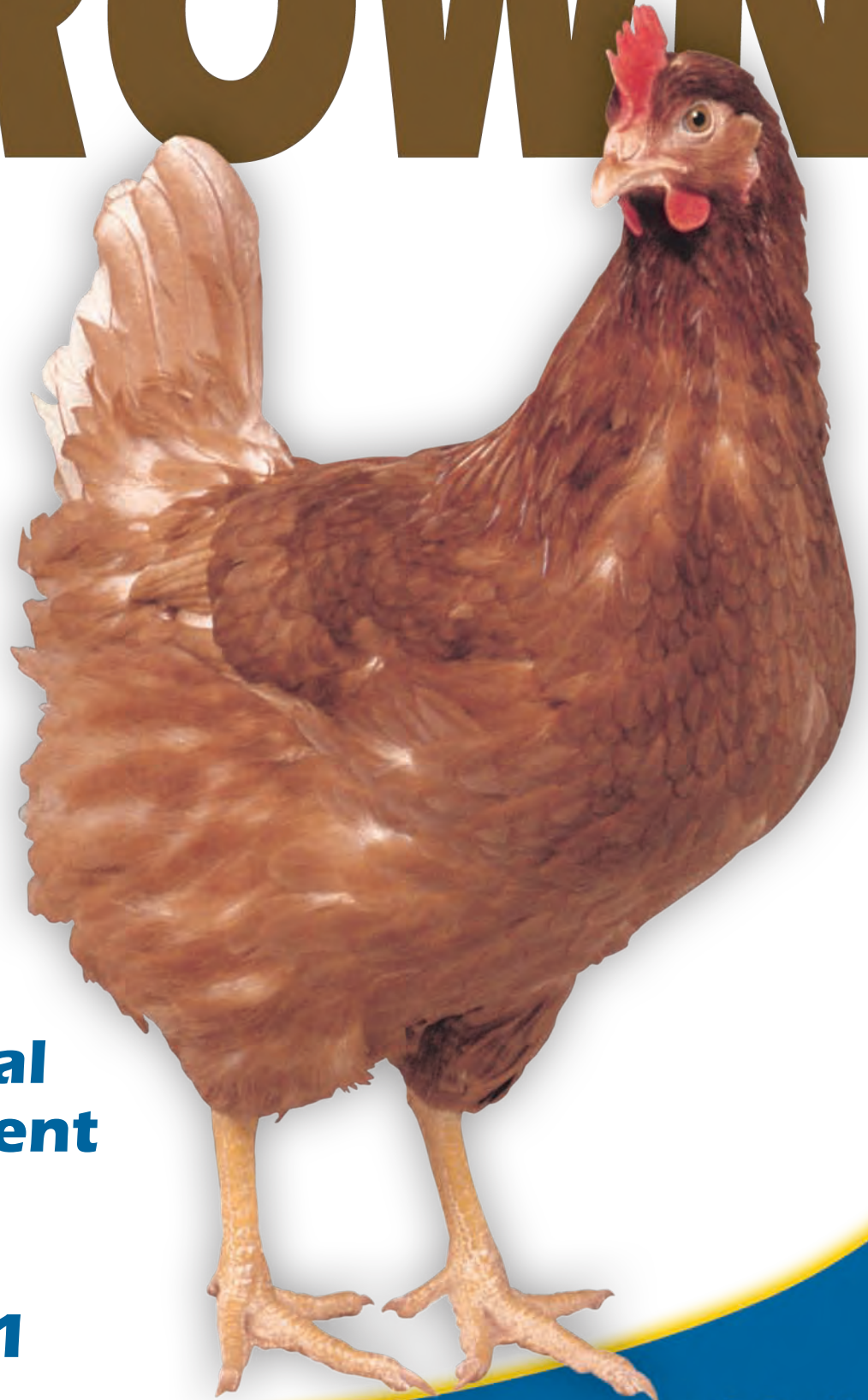

**Commercial
Management
Guide**

2009-2011

Genetic Excellence®

General Management Recommendations

The genetic potential of Hy-Line varieties can only be realized if good poultry husbandry practices and management are used. This booklet outlines successful flock management programs and provides management recommendations for Hy-Line's varieties based on field experience compiled by Hy-Line, extensive commercial flock records cataloged by Hy-Line from all parts of the world and principles taken from industry technical literature.

The information and suggestions contained in this booklet should be used for guidance and educational purposes only, recognizing that local environmental and disease conditions may vary and a guide cannot cover all possible circumstances. While every attempt has been made to ensure that the information presented is accurate and reliable at the time of publication, Hy-Line cannot accept responsibility for any errors, omissions or inaccuracies in such information or management suggestions. Further, Hy-Line does not warrant or make any representations or guarantees regarding the use, validity, accuracy, or reliability of, or flock performance or productivity resulting from the use of, or otherwise respecting, such information or management suggestions. In no event shall Hy-Line be liable for any special, indirect or consequential damages or special damages whatsoever arising out of or in connection with the use of the information or management suggestions contained in this booklet.

Table of Contents

Capabilities of the Hy-Line Variety Brown	5
Chick Management.....	6
Growing Period Management.....	6
Cage Brooding.....	7
Floor Brooding.....	7
Beak Trimming	8
Floor Systems Management.....	9
Recommended Floor Densities for the Hy-Line Variety Brown Layer	10
Disease Control	11
Internal Parasites.....	12
External Parasites	13
Lighting Program	14
Sunrise Sunset Chart	15
Egg Size Management	16
Monitoring Body Weights.....	17
Nutritional Recommendations	18
Growing Period Nutritional Recommendations.....	21
Growing Period Feed Consumption	22
Laying Period Nutritional Recommendations	23
Added Trace Minerals and Vitamins.....	26
Water Consumption.....	27
Ventilation.....	28
Non-Fast Molting	28
Non-Fast Molting Recommendations	29
Post-Molt Nutritional Recommendations	30
Hy-Line Variety Brown Performance Table	32
Hy-Line Variety Brown Hen-Day Performance Graph	34
Hy-Line Variety Brown Post-Molt Performance Table	35
Hy-Line Variety Brown Hen-Day Performance Graph Molted Flocks.....	37
Egg Size Distribution—U.S. Standards	38
Egg Size Distribution—European Standards.....	39
Feed Ingredient Analysis Table	40

Capabilities of the Hy-Line Variety Brown

Growing Period (to 17 weeks):

Livability	97%
Feed Consumed	5.62 kg (12.4 lb)
Body Weight at 17 Weeks	1.40 kg (3.09 lb)

Laying Period (to 110 weeks):

Percent Peak	94–96%
Hen-Day Eggs to 60 Weeks	249–257
Hen-Day Eggs to 80 Weeks	358–368
Hen-Day Eggs to 110 Weeks	487–497
Hen-Housed Eggs to 60 Weeks	245–253
Hen-Housed Eggs to 80 Weeks	348–358
Hen Housed Eggs to 110 Weeks	465–475
Livability to 60 Weeks	97%
Livability to 80 Weeks	94%
Days to 50% Production (from hatch)	142 Days
Egg Weight at 26 Weeks	58.5 g/egg (46.4 lb/case)
Egg Weight at 32 Weeks	61.6 g/egg (48.9 lb/case)
Egg Weight at 70 Weeks	64.4 g/egg (51.1 lb/case)
Total Egg Mass per Hen-Housed (18–80 weeks)	21.7 kg (47.8 lb)
Body Weight at 32 Weeks	1.91 kg (4.21 lb)
Body Weight at 70 Weeks	1.98 kg (4.37 lb)
Freedom from Egg Inclusions	Excellent
Shell Strength	Excellent
Shell Color at 38 Weeks	87
Shell Color at 56 Weeks	85
Shell Color at 70 Weeks	81
Haugh Units at 38 Weeks	90
Haugh Units at 56 Weeks	84
Haugh Units at 70 Weeks	81
Average Daily Feed Consumption (18–80 weeks)	107 g/day per bird (23.6 lb/day per 100 birds)
lb Feed/lb Eggs or kg Feed/kg Eggs (20–60 weeks)	2.02
lb Feed/lb Eggs or kg Feed/kg Eggs (20–80 weeks)	2.07
Feed per Dozen Eggs (20–60 weeks)	1.49 kg (3.28 lb)
Feed per Dozen Eggs (20–80 weeks)	1.55 kg (3.42 lb)
Skin Color	Yellow
Condition of Droppings	Dry

Chick Management

Hy-Line Variety Brown (Hy-Line Brown) chicks adapt equally well to floor and cage brooding systems. They require no special hatchery services except vaccination against Marek's disease.

General Recommendations

1. Prior to delivery of chicks:
 - a. Clean and disinfect cages or floor brooding area and equipment, the building interior and attached service areas and equipment.
 - b. Check to make sure equipment is working properly and is adjusted to the right height.
 - c. Remove all old feed from bins, hoppers, and troughs. Disinfect and allow to dry before new feed is delivered.
 - d. Place rodenticide where it will not be consumed by the chicks.
2. One day before delivery:
 - a. Set heating system at 34–36°C (93–97°F) for cage brooding or at 35–36°C (95–97°F) at chick level for floor brooding.
 - b. Check water system. Adjust to proper height for chicks. Disinfect and flush water lines.
3. On delivery day:
 - a. Have waterers full or water system in operation. Check brooder temperatures.
 - b. As chicks are placed, trigger water cups or nipples to encourage drinking.
 - c. When nipple drinkers are used, reduce the water pressure so birds can see the drop of water hanging on the drinker.
 - d. Feed should be placed on paper in cage. Operate feeders at highest feed level.
 - e. Keep light at high intensity 20–22 hours per day for the first week.

Growing Period Management

The first 17 weeks of a pullet's life are critical. Astute management during this period can assure that she reaches the laying house ready to deliver her bred-in performance potential. Mistakes made during the first 17 weeks generally cannot be corrected in the laying house.

General Recommendations

1. Grow pullets in strict isolation from older birds. Maintain good sanitation. Plan work routines so that disease causing agents cannot be carried from older birds to the growing pullets.
2. During the first six weeks, operate feeders to provide feed at least twice daily, or more often. After six weeks, check feed consumption and body weights against the charts on page 20 and 21.
3. Weigh 100 pullets weekly during the growing period, beginning at five weeks of age.
4. Check water availability in each cage row daily. Check for and repair leaks. Raise waterers as the birds grow (nipples higher than the birds' heads; cups or troughs level with their backs).
5. Plan and follow a vaccination schedule to fit the area (see page 10). A Hy-Line representative can be of assistance in making recommendations.
6. Remove mortality daily and dispose of properly. Examine for causes of excessive mortality.
7. Three days before moving pullets to the laying house, begin using water-soluble vitamins and electrolytes in the drinking water. Continue for three days after housing. This helps minimize the stress of moving. Handle birds gently during transfer to avoid injuries.
8. Pullets should be housed at 17 weeks of age, before the onset of sexual maturity.

Growing Space Recommendations			
Cage		Floor	
Floor Space:	310 cm ² (48 sq in)	Floor Space:	835 cm ² (0.9 sq ft)
Feeder Access:	5 cm/bird (2 in/bird)	Feeder Access:	5 cm/bird (2 in/bird) 1 pan/50 birds
Water Access:		Water Access:	
Trough:	2.5 cm/bird (1.0 in/bird)	Trough:	2.0 cm/bird (0.8 in/bird)
Cups/Nipples:	1 per 8 birds	Cups/Nipples:	1 per 15 birds
Fountains:	—	Fountains:	1 per 150 birds

Cage Brooding

Before the birds arrive, prepare the house as follows:

1. Put nonskid paper on the bottom of the cage. This paper may disintegrate and fall through the cage bottom or it should be removed at beak trimming time (10 days).
2. Start the heating system 24 hours before the birds arrive. Adjust the temperature to 34–36°C (93–97°F).
3. Keep the relative humidity at 40–60%. In cage brooding, maintaining adequate humidity is very important. If necessary, sprinkle water on the walks or floors to increase humidity.

Temperature Management

Look for signs of overheating (panting and drowsiness) or chilling (huddling and loud chirping) and make appropriate adjustments. Heat control is more critical in cage brooding because the chicks cannot move to find their comfort zone.

Floor Brooding

Twenty-four hours before delivery of the chicks, prepare the house as follows:

1. Place a brooder ring around each brooder unit.
2. Adjust temperature to 35–36°C (95–97°F).
3. Fill jug waterers—two 4-liter (one gallon) waterers per 100 chicks.
4. Eliminate all drafts from the house.

Temperature Management

Observing the chicks will tell you whether or not the temperature is correct. If they are too cool, they will huddle near the heat source. If they are too warm, they will spread out away from the heat source. If there are drafts, they will huddle in groups to get away from the spot where the cool air enters the heated area. Comfortable chicks will spread out uniformly, without huddling, throughout the brooding area.

Maintain adequate relative humidity for birds brooded on the floor. The chicks seem to be comfortable and do better when relative humidity is 40–60%.

Brooding Temperatures				
Age	Cage Brooding		Floor Brooding	
	°C	°F	°C	°F
Day 1–3	34–36	93–97	35–36	95–97
Day 4–7	30–32	86–90	33–35	92–95
Day 8–14	28–30	82–86	31–33	89–91
Day 15–21	26–28	78–82	29–31	84–87
Day 22–28	23–26	74–78	26–27	79–81
Day 29–35	21–23	70–74	23–25	74–77
Day 36→	21	70	21	70

Beak Trimming

Beak trimming is not necessary in all management systems, however, if beak trimming is done, proper procedures should be followed.

The Hy-Line Brown pullets are most successfully beak trimmed at hatch by infrared beak treatment or between 7–10 days of age using a precision cam activated beak trimmer with guide plate holes of 4.00, 4.37, and 4.75 mm (10/64, 11/64, and 12/64 in). The proper size hole should be selected to provide the width of 2 mm between the nostrils and the cauterizing ring. The proper size hole will depend both on size and age of the chicks.

A cherry red color blade has been recommended for proper cautery. However, a better way to measure blade temperature is by use of a pyrometer to keep the blade at approximately 595°C (1100°F). The use of a line voltage meter and chart available from the Hy-Line website will facilitate maintaining the proper blade temperature at all times. A variation of 38°C (100°F) is common due to external influences and cannot be detected by the human eye.

The following precautions must be observed at all times:

1. Do not beak-trim sick birds.
2. Do not hurry.
3. Use electrolytes and vitamins (containing vitamin K) in the water two days before and two days after beak trimming.
4. Keep feed at the highest level for several days after beak trimming. If a coccidiostat is being used in the feed, supplement it with water soluble coccidiostats until feed consumption returns to normal.
5. Use only well trained crews for beak trimming.

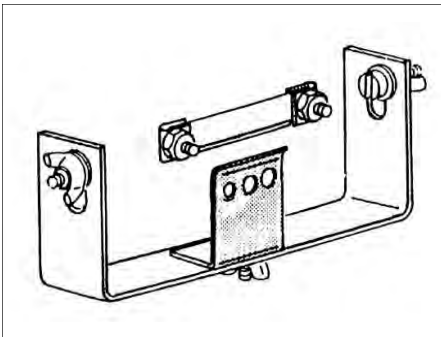

Guide plate holes for precision beak trim.



7–10 day old chick immediately after beak trim.



Infrared beak treatment at hatch as shown at 4 days of age.

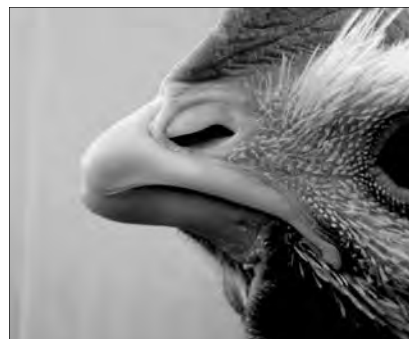

The result of an appropriate beak trim as it appears at 18 weeks of age.

Floor Systems Management

The Hy-Line Brown can be used successfully in floor systems due to her good livability and nest behavior when the birds have been appropriately socialized. It is important to provide the birds with the best possible floor environment to achieve the performance potential of the Hy-Line Brown. It is essential to grow the birds on the floor when they will be housed in floor systems for the laying period.

Growing Period

Lighting—Birds should be grown in housing that allows adjustment to the lighting program and the light intensity. The lighting programs are usually similar to those used for birds in cage production, but light intensity may be different. It is important to provide floor grown birds with enough light intensity to allow them to navigate their environment. Week-one light intensity of 20–30 lux (2–3 foot-candles) should be used, dropping down to 15 lux (1.5 foot-candles) by week four and remaining at the level until week 15. At week 15, gradually increase the light intensity, reaching 20–30 lux (2–3 foot-candles) by the time the pullets are transferred to the layer house. Birds moving into open-sided housing should have higher light intensities of 30–40 lux (3–4 foot-candles) at the time of housing.

Perches—Perches provide a significant improvement to the growing and laying house environment. In grow, they allow birds to fully develop their leg and flight muscles which are essential in the birds ability to navigate the lay house environment. Perches reduce the social stress of the floor by providing a roost for rest periods. The perches also reduce the social pressure in the environment as they use the total available space in the house efficiently increasing floor space. Piling is a common problem in flocks who do not have access to perches. Place perches on slats where possible to maintain good litter conditions. Distance between perches on A-frame design should be 40 cm (16 in) and at a slope of 45°. The length of the perch depends on the bird density (as shown in the table below).

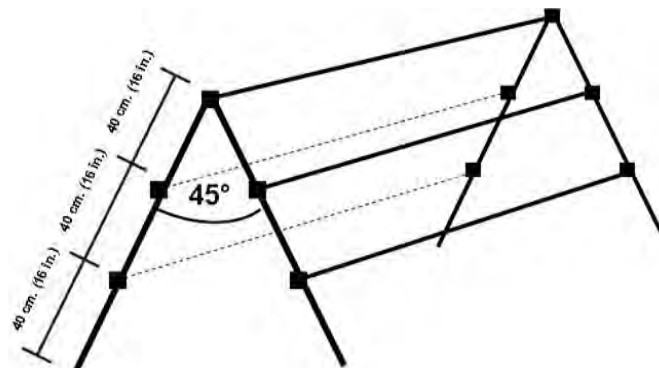

Perch Dimensions

Body Weight—It is essential that birds have access to the same type of feeder and water system in the growing house that they will have in the laying house. Birds will adapt better in the lay house if the growing house has perches. Ideally, the growing house should have elevated bird walkways with feed and water stations.

Birds grown on the floor will often be as much as 50 g (0.1 lb) lower in body weight at 12 weeks of age than cage-grown birds. To offset any decrease in egg size, it is common to delay light stimulation until the pullets reach 1.40 kg (3.1 lb) at 17 weeks of age.

Relative Humidity—Birds are very sensitive to extremes of relative humidity. It is common to see young flocks in floor houses with relative humidity dropping below 30%. This will cause increased agitation of the chicks and can cause aggressive behavior. Excessive moisture may cause poor litter conditions. Wet litter will be associated with high ammonia levels, poor air quality and enteric diseases. This must be avoided to prevent respiratory problems. Ideally, relative humidity should be in the 40–60% range.

Socialization—It is important to socialize the birds to humans by walking through the chicks daily. It is recommended the birds be walked at two hour intervals. This would give the birds time to relax and settle between walkings. Brighten the house and walk briskly through the house to improve the process of socialization.

<u>Bird Density</u>		<u>Length per Bird</u>	
<u>Birds/m²</u>	<u>ft²/bird</u>	<u>cm</u>	<u>in</u>
7	1.6	4	1.50
8	1.5	6	2.25
9	1.4	8	3.00
10	1.3	12	4.50
12	1.0	14	5.50

Floor Systems Management

Laying Period

Lighting—Ensure that the feed and water systems in the growing and laying facilities are compatible. Check the lighting program and light intensity. Synchronize light times with the growing house. The Hy-Line Brown layer will need bright light of at least 20 lux (2 foot-candles). It is important not to have shadows in the lay house, as dark areas outside the nest will encourage floor eggs. Allow the pullets access to the nests during the day when they arrive. Place the pullets on the slats at housing. Walk the birds several times daily, particularly in the morning, to ensure the birds are finding feed and water.

Training Period—Training the birds to use the nest will require frequent walks through the birds in the mornings for the first eight weeks after the birds are placed in the laying house. Use of electric fence on the slats around the house perimeter is helpful in discouraging egg laying in corners or near the walls. The fence must be turned on as soon as the birds are housed. Place the electric wires 5 cm (2 in) away from the wall or the house and about 10 cm (4 in) above the floor.

An electric fence over water and feed lines can be counter productive as they increase nervousness among the birds and should be avoided. Use of solid perches above water and feed lines are preferred.

Nests—Consider opening nest box curtains to encourage nest exploration in young laying flocks. Nest lights can be used to train birds to explore the nests and should be turned on one hour before the house lights are turned on and remain on for one hour after the house have been turned on. This will help prevent smothering inside the nests. Create false walls that are 1 m (3 ft) in length every 12 m (39 ft) along the line of nest boxes.

House Layout—The litter area in layer houses should not be more than 60 cm (24 in) below the slat area. Position lights to eliminate shadows on the litter below the slat area. Position lights to provide the brightest light intensity over the litter or resting areas and the lowest light intensity at the front of the nest boxes. Flocks housed in all-slat houses should also be grown on slat or wire floors.

Recommended Floor Densities for the Hy-Line Brown Layer

Floor Space:	all litter	8 birds/m ² (1.3 sq ft/bird)
	all slat	10 birds/m ² (1.1 sq ft/bird)
	combination of litter/slat	9 birds/m ² (1.2 sq ft/bird)
Feeder Access:	straight trough	9 cm (3.5 in)
	round pans	30 birds
Water Access:	1 nipple/cup	per 10 birds
	2.5 cm (1 in) water trough	per bird
	46 cm (18 in) diameter circular	
	automatic water fountain	per 125 birds
Nest Space:	colony nest, single tier, 1.1–1.4 m (3.5–4.5 ft) width	150 birds/nest (75 birds/side)
	individual nest	8 birds/nest

Disease Control

A flock of pullets or layers can only perform up to its genetic potential when disease influence is minimized. The appearance of various diseases can vary from a sub-clinical effect on performance to outright severe mortality. The diseases of economic importance vary widely between locations, but in every case the challenge is to identify and control those diseases.

Biosecurity

Biosecurity is the best method of avoiding disease. A good biosecurity program identifies and controls the most likely ways a disease could enter the farm. Human and equipment movement onto the farm should be strictly controlled. Visitors to the farm should be limited to those who are essential for its operation. All visitors and workers should enter at a central location. Visitors should use a logbook to document their visits. Anyone having been on another poultry facility within 48 hours should not be permitted access. Clean boots, clothing and head cover should be provided for everyone working or visiting the farm. Clean footbaths containing disinfectant should be placed outside the entries to all poultry houses. If possible, avoid using outside crews or equipment for vaccination, moving, and beak trimming. Ideally, workers should be limited to a single house. The number of flocks visited in one day should be limited, and always progressing from younger to older flocks, and from healthy to sick flocks. After visiting a sick flock, no other flocks should be visited.

The removal of old hens from the farm is a time when disease can be introduced. The trucks and crews used to transport old hens have often been on other farms. A plan should be developed to minimize the biosecurity risk during times outside crews or equipment are needed for vaccination, moving pullets, and beak trimming.

A single-aged growing farm using the all-in/all-out principle is best. This will prevent the transmission of disease from older flocks to younger, susceptible flocks. All houses should be designed to prevent exposure of the flock to wild birds. Quickly and properly dispose of dead chickens.

Rodents are known carriers of many poultry diseases and they are the most common reason for re-contamination of a cleaned and disinfected poultry facility. They are also responsible for house-to-house spread of disease on a farm. The farm should be free of debris and tall grass that might provide cover for rodents. The perimeter of the house should have a 1 m (3 ft) area of crushed rock or concrete to prevent rodents from burrowing into the houses. Feed and eggs should be stored in rodent-proof areas. Bait stations should be placed throughout the house and maintained with fresh rodenticide.

Cleaning and disinfection of the house between flocks serves to reduce the infection pressure for a new incoming flock. The house should be cleaned of organic matter by high pressure spraying with a warm water containing a detergent/disinfectant. Allow time for the detergent to soak.

After drying, the house should be disinfected or fumigated and allowed to dry again before repopulating with birds.

Heating the house during washing improves the removal of organic matter. Wash the upper portion of the house before the pit. Thoroughly clean the air inlets, fan housing, fan blades and fan louvers. Flush and sanitize the water lines. All feed and manure should be removed from the housing before cleaning. Allow a minimum of two weeks downtime between flocks. Monitoring of poultry houses for the presence of pathogenic species of *Salmonella*, particularly *Salmonella enteritidis*, is recommended. This can be done by routine testing of the environment using drag swabs.

Vertically Transmitted Diseases

Some diseases are known to be transmitted from infected breeders to their progeny. This requires the production and maintenance of disease-free breeders as a first step in the control of these diseases at the commercial level. All breeders directly under Hy-Line's control are free of *Mycoplasma gallisepticum*, *Mycoplasma synoviae*, *Salmonella pullorum*, *Salmonella gallinarum* (typhoid), *Salmonella enteritidis*, and lymphoid leukosis. Due to the possibility of horizontal transmission of any of these diseases, later generations may not remain free. It is the responsibility of the breeding and commercial flock owner to prevent horizontal transmission of these diseases and to continue testing to be assured of a negative status.

Vaccination

Certain diseases are too widespread or difficult to eradicate and require a routine vaccination program. In general, all layer flocks should be vaccinated against Newcastle, bronchitis, Infectious Bursal Disease (IBD) and Avian Encephalomyelitis (AE). The exact vaccination schedule depends upon many things such as diseases exposures expected, maternal immunities, vaccine types available and routes of administration preferred. Therefore, no one program can be recommended for all locations. Consult with local veterinarians to determine the best vaccination program for your area. Following is a basic program where breeders received an inactivated Newcastle-bronchitis-IBD vaccine.

Basic Vaccination Program		
Age	Disease	Method
1 day	Marek's	injection
	HVT/SB-1 or HVT/Rispens	injection
18–20 days	Gumboro	water
24–26 days	Gumboro	water
	Newcastle-B-1 and bronchitis, mild Mass	water
30–32 days	Gumboro	water
7–8 weeks	Newcastle-B-1 and bronchitis, regular Mass	water or spray
10 weeks	Pox	wing-web
	AE	wing-web, water or spray
14 weeks	Newcastle LaSota and bronchitis, mild Holland or	spray
	Newcastle-bronchitis Killed virus	injection

Infectious Bursal Disease

Special attention should be paid to IBD control. This disease can have many subtle effects which are detrimental to pullet health. The primary feature of IBD is immuno-suppression caused by damage to the bursa of Fabricius which leaves the bird unable to fend off other disease challenges. Secondary diseases such as gangrenous dermatitis, bacterial arthritis, peritonitis, and even Marek's often result.

Virtually all flocks are exposed to IBD and therefore, should be protected by vaccination. Most breeding stock receives a killed IBD vaccine to boost maternal titers in the chicks. Research at Hy-Line International has shown the optimum time to vaccinate such chicks with intermediate strain live vaccines is at 18–20 days, 24–26 days and at 30–32 days of age. Extremely severe IBD challenge may require even more frequent vaccination during this period. Bursas can be examined later to determine the extent of protection.

Internal Parasites

Infections with internal parasites cause damage to the bird's gut. This may result in a variety of problems including:

- Loss of shell strength, yolk color, and egg size.
- Poor body weight gain leading to unevenness or stunted birds. Affected birds may be dull and show pale combs.
- Increased cannibalism through vent pecking due to straining.
- Death, in very heavy infestations.

There are three main worms that may cause problems in free-range or cage birds:

1. **Roundworms (*Ascaridia galli*)**
These are the largest and most common. They are white, up to 5 cm (2 in) long and may be visible in droppings in heavy infestations.
2. **Hairworms (*Capillaria*)**
These are much smaller (hair-like) and are barely visible with the naked eye but can cause significant damage even in only moderate infestations.
3. **Cecal worms (*Heterakis gallinarum*)**
As their name suggests, these worms spend most of their time in the lower end of the gut, the ceca. They cause no obvious harm in themselves, but can carry another parasite, *Histomonas*, into the birds. *Histomonas* is the cause of blackhead and hence control of one parasite can help to control another.

Birds become infected by picking up worm eggs from litter, soil, or feces. The worm eggs need warm moist conditions to develop outside the bird, which is why problems are frequently worse in the spring and summer, especially following a wet spring. Worm burdens can be identified by examination of feces, culled birds, or worm egg counts on bulk feces.

A product used for roundworm treatment in the United States is piperazine at 50 mg/bird (0.1%) for 24 hours. A possible licensed dewormer in some countries for laying birds is flubendazole. This product has no withdrawal period, which means that it can be given in the feed during lay without the need to discard eggs, except in organic diets where eggs may need to be withheld.

Effective control is aimed at breaking the cycle of infection. Strategic use of anti-parasitic drugs (in the rearing phase) will help to reduce challenge, but this needs to be combined with limiting stock density on land, the use of range rotation, good drainage, and the removal of heavily contaminated soil around the house before new pullets arrive.

Coccidia

This parasitic infection of the intestines can lead to gut damage and, in severe infestations, death of birds. More commonly, poor control of sub-clinical infection reduces feed conversion, or leaves pullets with chronic irreversible gut damage. Such flocks may be uneven or underweight at housing, and may not perform to their full potential in lay. Currently, effective control is achieved with drug treatments in feed that suppress oocyst output. These may involve the use of ionophores or chemicals on a step-down program to ensure immunity in pullets. An alternative to anti-coccidial drug treatments is using a live vaccine. Live coccidial vaccines are available that can be administered by spray in the hatchery or by feed or water application the first few days in the brooder house. All treatment/vaccination strategies should be supported with effective biosecurity. The use of a disinfectant with proven efficacy against coccidial oocysts will reduce challenge pressure. Maintenance of good dry litter will reduce oocyst build up.

External Parasites

Red Mite or Northern Fowl Mite

Mites are a cause of increasing problems in free-range and caged layers. It is particularly severe in the summer months when the weather is warm and mites are able to multiply quickly.

Even light infestations can irritate the birds, leading to poor performance and reduced feed intake. In more severe cases, infestations can lead to some or all of the following:

- Mites irritate the birds and can make the flock unsettled and nervous.
- The incidence of peritonitis may increase and there may be increased vent pecking.
- Feed intake may be depressed.
- Heavy mite infestations can depress egg production up to 5%.
- Heavy infestations of red mites will make birds anemic due to loss of blood. Birds will be evident in the flock with pale combs and, if severely affected, mortality may increase.
- There may be loss of yolk color and, with heavy infestations of red mites, there will be evidence of mites and mite feces on eggs and egg belts, which may lead to downgrading of speckled eggs.
- There may be an increase in floor eggs as birds will be reluctant to use heavily infested nests.
- Where there are heavy mite infestations, egg collectors may experience skin irritation.

Control strategies involve two broad areas:

1. Breaking the cycle of re-infection when the house is empty is the most effective approach. Treat the houses effectively at site depletion with an approved product, properly applied, to reach into all crevices on equipment, slats, and nest boxes. Use a fan nozzle to produce a flat spray. Do not mix pesticides with disinfectants, unless recommended by the manufacturer.
2. Monitor the house and birds during the life of the flock to allow prompt treatment even if only light infestations are identified. Programs for treatment to break the Northern Fowl Mite life cycle (5–7 days) should be done three times on day 0, 5, and 10. Treatment to break the Red Mite life cycle (10 days) should be done three times on day 0, 10, and 20.

Lighting Program

Egg production is very closely related to the changes in day length to which the pullets are exposed. Egg numbers, egg size, livability and total profitability can be favorably influenced by a proper lighting program.

1. Start pullets with 20–22 hours of light the first week at 30 lux (3 foot-candles) intensity. Reduce light to 20 hours the second week at 5 lux (0.5 foot-candle). The following weeks, reduce light duration to reach 10–12 hours day length by 7–9 weeks of age or in open houses, the longest natural day length between 6 and 17 weeks of age (see example page 10).
2. Provide the light stimulation when body weight is 1.48 kg (3.3 lb). The initial increase should be one hour or less. Increase light by 15–30 minutes per week or biweekly until 16 hours of light is reached. Preferably the period of stimulation should last until 28–32 weeks of age. Light intensity should also be increased at housing to 10–30 lux (1–3 foot-candles).
3. Allow no decrease in day length or light intensity in adult layers.

Local sunrise-sunset timetables should be obtained to accurately design individual programs. Guidelines are as follows:

1. Light-controlled growing to light-controlled laying:
 - a. Step-down day length from 20–22 hours the first week to 8–10 hours by 7–9 weeks of age. Then maintain a constant day length to 17 weeks.
 - b. Increase day length 1 hour at 1.48 kg (3.3 lb). Add 15–30 minutes per week until 16 hours total light is reached.
2. Light-controlled growing to open or brownout laying:
 - a. Step-down day length from 20–22 hours the first week to 8–10 hours by 7–9 weeks of age, or one hour less than natural day length at 17 weeks of age.
 - b. Increase to natural day length or a minimum increase of 1 hour at 1.48 kg (3.3 lb). Add 15–30 minutes per week or biweekly until 16 hours total light, or at least the longest natural day length of the year.
3. Open or brownout growing to light-controlled laying:
 - a. Step-down day length from 20–22 hours the first week to 8–10 hours by 7–9 weeks of age or, if longer, the longest natural day length between 6 and 17 weeks of age.
 - b. Increase day length one hour at 1.48 kg (3.3 lb). Add 15–30 minutes per week or every 2 weeks until 16 hours of total light is reached.
4. Open or brownout growing to open or brownout laying:
 - a. Step-down day length from 20–22 hours the first week to 8–10 hours by 7–9 weeks of age or the longest natural day length between 6 and 17 weeks of age.
 - b. Increase one hour at 1.48 kg (3.3 lb). Add 15–30 minutes per week or every 2 weeks until 16 hours of total light is reached, or at least the longest natural day length of the year.

Timing of Light Stimulation

Onset of sexual maturity or egg production generally depends on four requirements:

1. A minimum chronological age which is genetically determined (18 weeks).
2. A minimum body weight (1.48 kg or 3.3 lb).
3. A nutrient intake to support production.
4. A constant or increasing day length of at least 12 hours.

Light stimulation should not be provided until flocks reach the optimum body weight of 1.48 kg (3.3 lb). Flocks which are light-stimulated into production at lower body weights will likely produce below normal egg size and suffer from reduced peak production and post-peak drops in production.

Timing of light stimulation can be used as a tool to help attain desired egg size. In general, earlier light stimulation will result in a few more eggs per hen, but at a tradeoff for slightly reduced egg size. Later light stimulation will result in a few less total eggs, but a slightly larger egg size earlier in production. In this way, lighting programs can be customized to best meet the egg size demand of a particular market.

Midnight Feeding

An optional lighting technique that will promote more feed consumption is the “midnight feeding.” The technique involves turning the lights on for 1 hour in the middle of the dark period and running the feeders during this time. For a typical layer lighting program with 16 hours of light and 8 hours dark, the night would consist of 3.5 hours of darkness, one hour of light, and 3.5 hours of darkness. The regular 16 hour light period should not be changed. The hour of light can be added all at once, but if it is removed at a later time, that should be done gradually, at the rate of 15 minutes per week. Midnight feeding will generally increase feed intake about 2–5 g/day per bird (0.4–1.0 lb/day per 100 birds). The technique is applicable for heat stress conditions, or any time more feed intake is desired in either growing or laying flocks.

Planning Individual Light Programs

When open-type houses are used, which allow natural daylight to affect the flock, the lighting program must be planned in conjunction with changes in the natural day length. Because no two places have the same sunrise-sunset times year-round, it is impractical to suggest time clock settings that would apply to all locations. For the most precise planning, custom lighting programs for any location worldwide are available on the Hy-Line website (www.hyline.com).

In the example shown on the next page, the growing flock is maturing in the spring when there is a naturally increasing day length. To prevent early sexual development, find the natural day length at 17 weeks of age and hold that day length constant with artificial lights from 8 to 17 weeks.

Sunrise Sunset Chart

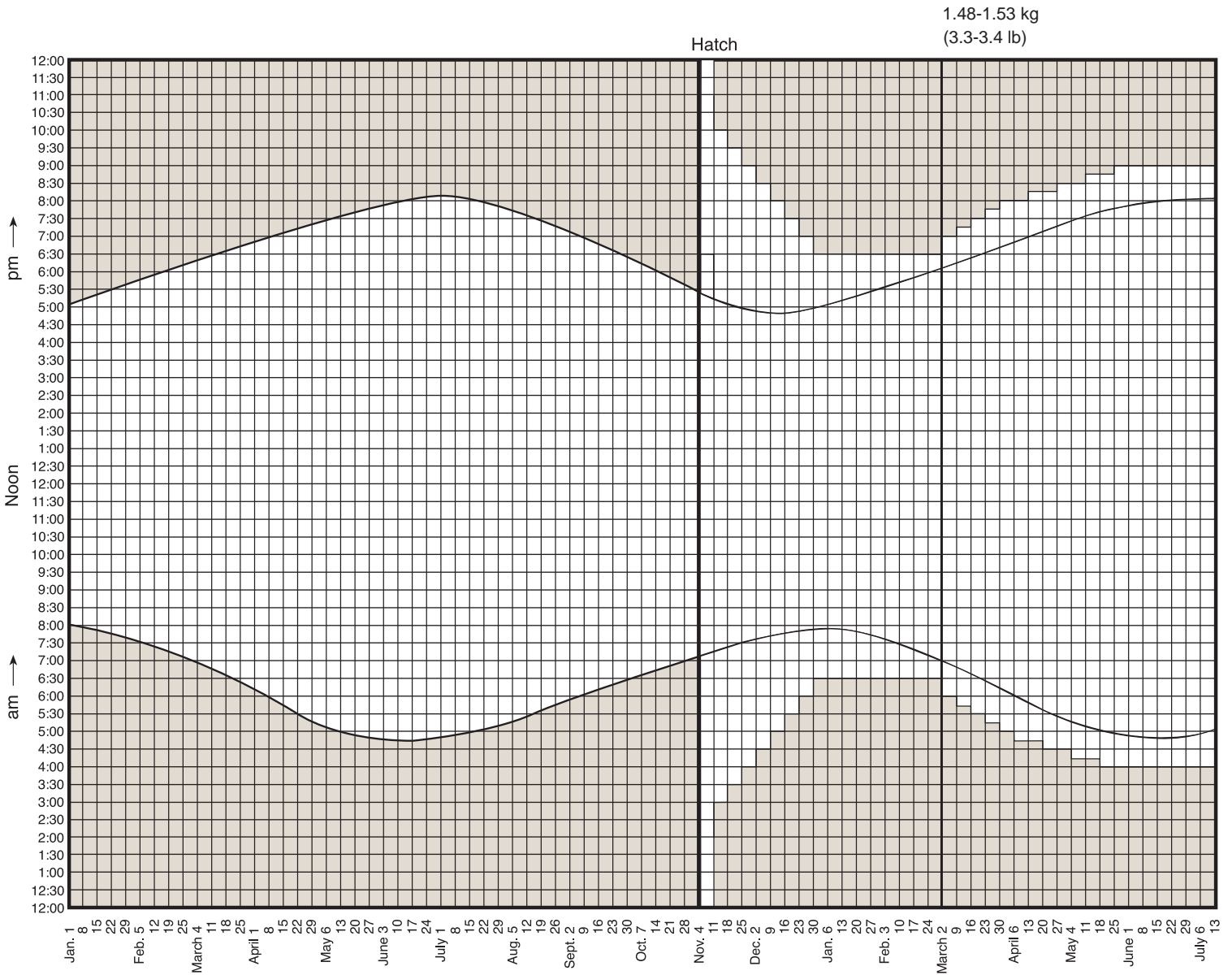

Lighting Program

Hy-Line International Web Lighting Program

Enter your e-mail address (i.e. johncox@hyline.com)
Hy-Line@hyline.com

English

Click here to e-mail a problem to our IT staff

Select location of flock

EUROPE
UK
HEATHROW-LONDON

Click here if your farm location is not in our global database!

Housing Style

Open grow to dark lay

Hatch Date

12/12/2008

≤ December 2008 ≥

Su	Mo	Tu	We	Th	Fr	Sa
30	1	2	3	4	5	6
7	8	9	10	11	12	13
14	15	16	17	18	19	20
21	22	23	24	25	26	27
28	29	30	31	1	2	3
4	5	6	7	8	9	10

Variety Standards

Brown Commercial

Age to stepdown to from week 1

8

Hours of constant light in grow after step-down

9.00

Age to start light stimulation at maturity

17

Hours of constant light in lay after step-up

16.00

Reset to Standard

Click to download/open...(last 5)
hy_line_21_Dec_2007_7_30_12.xls

Logoff

Create Lighting Spreadsheet

Developed by Hy-Line International

Egg Size Management

Egg size is to a large extent genetically determined, but within this given range, we can manage to either increase or decrease the egg size to suit the particular market needs.

The following management areas should be given particular attention.

1. **Body weight at maturity**—The larger the body weight at first egg, the larger that hen's eggs will be for her entire life. For optimum egg size, do not stimulate maturity with lights until a body weight of 1.48 kg (3.3 lb) is attained.
2. **Rate of maturity**—This also relates to body size, but in general the earlier the age a flock begins

production, the smaller the egg size will be, and likewise, the later the maturity, the larger the egg size. Lighting programs can be manipulated to influence rate of maturity. A decreasing light pattern continuing past 10 weeks will delay maturity and increase average egg size.

3. **Nutrition**—Egg size is greatly affected by the intake of energy, total fat, crude protein, methionine and cystine, and linoleic acid. Levels of these nutrients can be increased to improve early egg size and gradually reduced to control late egg size (see layer feeding program page 23).

Monitoring Body Weights

Body weights should be monitored periodically during the growing period and until after peak. At least 100 birds should be weighed individually with a scale having increments no larger than 50 g (0.1 lb). Weighing should be started at three weeks of age and continued every two weeks during the growing period and until after peak. It is most critical to weigh just prior to a scheduled feed change. If the flock is below target body weight, it should be left on the higher nutrient feed formulation until the target weight-for-age is reached.

It is best to produce a large-framed pullet, but one that is not overweight or excessively fat. Encourage early feed consumption to stimulate growth and frame development, but avoid excessive weight gain in the period of 12–18 weeks of age.

Factors which can adversely affect body weight and uniformity are crowding, disease, poor beak trimming and inadequate nutrient and energy intake. Weighing at frequent intervals will determine the age at which a flock deviates from normal and thereby helps identify the problem so that corrective measures can be taken.

Variability Between Individual Birds Within a Flock

For example, if the average flock weight at 18 weeks is 1.48 kg (3.3 lb), 80% of all birds should weigh between 1.33 kg (2.9 lb) and 1.63 kg (3.6 lb). Graph individual weights to be sure there is a bell shaped or "normal" distribution as shown below.

To evaluate uniformity, at least 100 individual birds should be weighed. Typically, uniformity reaches 90% at point of lay, with lower values in younger and older birds.

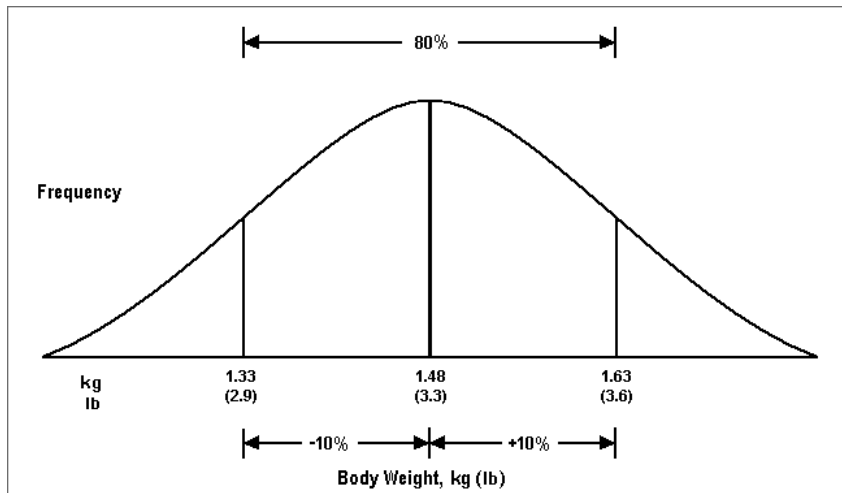

Target Weights of Hy-Line Variety Brown Pullets*
—Growing Period—

Age Weeks	Body Weight	
	g	lb
1	70	0.15
2	120	0.26
3	200	0.44
4	250	0.55
5	335	0.74
6	450	0.99
7	540	1.19
8	640	1.41
9	750	1.65
10	860	1.90
11	960	2.12
12	1070	2.36
13	1120	2.47
14	1200	2.65
15	1260	2.78
16	1320	2.91
Move to Lay House	1400	3.09
18	1480	3.26

*Pullets grown on the floor, or in a tropical climate, can be 50 g (0.1 lb) lighter than shown.

Nutritional Recommendations

The nutritional recommendations presented in this guide result in excellent production in a wide variety of situations, however, specific conditions may require advice from a professional nutritionist.

Feed Management

Regularly empty, clean, and disinfect feed bins and avoid unnecessary build-up of dusty, stale, moldy, and unpalatable feed. Birds should be allowed to occasionally empty feeders to avoid feed build-up in the feeders. Order feed in good time to avoid running out of feed. Upon feed delivery, before discharge, ensure that the correct product and quantities have been delivered and that it is delivered to the correct feed bin. During discharge, collect representable feed samples and label the sample bags appropriately before storage (preferably in a freezer at -20°C) for at least 4 weeks. Inspect the feed visually for particle size, color, and smell and compare it with previous samples. In the event of a significant deviation from the norm, inform your feed supplier immediately. Consider returning the load and, if so, send a feed sample to a laboratory for analysis to verify the suspected defect. Periodically, feed samples should be sent to a laboratory for

analysis of nutrient content (e.g., moisture, amino acids, fat, crude protein) and for comparison with the supplier's guarantees.

Energy

Energy is supplied by dietary nutrients (i.e., fats, carbohydrates, and amino acids) and is necessary for growth and egg production. For poultry, metabolizable energy (defined as gross energy minus losses of energy in feces, urine, and gaseous products) is used to express the available-energy content of feed ingredients and complete diets. However, as illustrated in the table below, differences in the metabolizable energy value assigned to feed ingredients of the same name differ substantially. Some of the differences can be attributed to differences in the feed ingredients' moisture content, but even when the metabolizable energy value is expressed on a dry matter basis, the assigned energy values differ. As a result, the calculated energy content of a given diet varies substantially depending on which assigned energy values were used for the individual feed ingredients.

Table values of selected feed ingredients showing differences in metabolizable energy values (as-fed values).						
Region	Corn (maize)		Wheat, soft		Soybean meal, 48%	
	kcal/kg	MJ/kg	kcal/kg	MJ/kg	kcal/kg	MJ/kg
United States of America ¹	3390	14.18	3210	13.43	2458	10.28
Brazil ²	3381	14.15	3046	12.74	2302	9.63
Netherlands ³	3415	14.29	3258	13.63	2309	9.66
France ⁴	3203	13.40	2988	12.50	2366	9.90
Europe ⁵	3289	13.79	3036	12.69	2323	9.72

¹Feedstuffs 2008 Reference issue and buyers guide. Feedstuffs, September 10, 2008. Minnetonka, Minnesota, USA.

²Rostagno, H. S. (ed.). 2005. Brazilian tables for poultry and swine. Composition of feedstuffs and nutritional requirements. 2nd ed. Departamento de Zootecnia, Universidade Federal de Vicosa, Brazil.

³Centraal Veevoederbureau (CVB). 2008. CVB Table booklet feeding of poultry. CVB-series no. 45. (values of ME for laying hens, "ME_l," are shown).

⁴Sauvant, D., J.-M. Perez, and G. Tran (eds). 2004. Tables of composition and nutritional value of feed materials. 2nd rev. ed. INRA-AFZ, France.

⁵Janssen, W. M. M. A. (ed.). 1989. European table of energy values for poultry feedstuffs. 3rd ed. Spederholt Center for Poultry Research and Information Services, Beekbergen, The Netherlands

The recommended metabolizable energy content of the diets in this guide is based on the assigned energy contents of feed ingredients commonly used in the United States of America using the nitrogen-corrected, apparent metabolizable energy system. These values are shown for selected feed ingredients on the inside back cover of this guide. When using feed-ingredient energy values that are substantially different from those shown in this guide, the recommended dietary energy content should be adjusted accordingly. Regardless of which energy system or dietary energy content that is used, there must be sufficient energy in the diet to meet the birds' need for maintenance, growth, and egg production. If the hens consume insufficient energy, body reserves will be used at first to maintain egg production, followed by reductions in egg weight, egg production, and body weight.

Protein and Amino Acids

Birds do not require protein, but rather the amino acids that make up protein. Although minimum recommendations for dietary crude protein contents are shown in the accompanying tables, it is strongly recommended that diets be formulated on an amino acid basis with no crude protein minimums. However, when no minimum crude protein content is specified, it is important to consider the content of *all* amino acids to avoid deficiencies. With the use of synthetic (crystalline) amino acids, the limiting amino acids in most diets will be tryptophan, valine, or isoleucine. Therefore, if the dietary contents of only methionine (plus cystine) and lysine are considered, a crude protein minimum should be specified to avoid deficiencies of other amino acids.

Nutritional Recommendations

A portion (typically 10–15%) of the dietary amino acids is not digested and instead excreted into the feces. Because the indigestible portion varies considerably among feed ingredients, it is highly recommended that diets are formulated on a digestible amino acid basis. For instance, soybean meal, meat and bone meal, and cottonseed meal contain about the same amounts of total methionine, but their methionine digestibilities differ widely:

Soybean meal (48%):	0.64% total methionine × 91% digestibility = 0.58% digestible methionine
Meat and bone meal (48%):	0.64% total methionine × 85% digestibility = 0.54% digestible methionine
Cottonseed meal (46%):	0.64% total methionine × 72% digestibility = 0.46% digestible methionine

Diets formulated on a total amino acid basis must contain large safety margins to account for the differences in digestible amino acid content of different feed ingredients. By formulating diets on a digestible amino acid basis, safety margins can be reduced and feed ingredients can be more accurately valued based on their content of bioavailable amino acids. Formulation of diets on a digestible amino acid basis is more accurate, results in more economical diets, and can reduce the impact on the environment compared to formulation on total amino acid basis or on a crude protein basis. Recommended amino acid digestibilities of selected feed ingredients are shown on the inside back cover of this guide.

Use of Exogenous Feed Enzymes

Exogenous feed enzymes can be effective in improving the digestibility of nutrients and energy in feed ingredients, thereby lowering diet cost and the impact on the environment. For instance, phytase can be used effectively to increase phosphorus bioavailability from phytate-containing ingredients, such as corn grain and soybean meal, whereas carbohydrases, such as xylanase and beta-glucanase, can effectively increase the diet's energy digestibility. However, the composition of the complete diet must be carefully considered to ensure that the exogenous enzymes have sufficient amounts of substrates to work on. For instance, the efficacy of phytase is greatest when all the phosphorus in the diet comes from phytate-containing ingredients. The available-phosphorus credit assigned to phytase should be higher in a diet containing corn and soybean meal than in a diet containing wheat, soybean meal, and meat-and-bone meal. Failure to consider the phytate content of the complete diet when assigning an available-phosphorus credit to the phytase product may lead to phosphorus deficiencies, resulting in poor egg production, osteomalacia, and gout. Similarly, failure to consider the xylan or beta-glucan content of the complete diet when assigning energy credits to a carbohydrase product may lead to insufficient energy consumption, resulting in reduced growth, egg weight, and egg production.

Feeding the Pullet

Feeding and management of pullets during the growing period have major effects on egg production and egg weights during the laying period. Mistakes made during the growing period can lead to poor production in lay and cannot easily be corrected during the laying period. Therefore, flexibility in pullet diet formulation and in the timing of diet changes is necessary to ensure that body weight and uniformity targets are met. Feeding the starter diet as crumbles can improve body weight gain and uniformity by increasing the chicks' feed consumption and avoiding selective feeding.

Diet changes are governed by target body weights, not bird age. Close monitoring of the pullet's body weight is therefore a key prerequisite for diet changes. If chicks are below the recommended target weight at 3 weeks of age (when a change from the starter diet to the grower diet is normally recommended), the starter diet should be fed longer until the target weight-for-age is met. If there is a large discrepancy between the pullets' body weight and the target weight, diets can be reformulated with higher energy concentrations. Pullets do not regulate feed consumption based on energy intake as well as mature laying hens do, and they will therefore respond to higher-energy density diets with an increase in body weight gain. Increasing the dietary energy content to promote growth in warm weather may not be as effective as in cool weather; therefore, the concentrations of amino acids, minerals, and vitamins should also be increased proportionally in these situations. Although high-density diets can be used to improve body weight gain, the sustained feeding of diets with higher-than-recommended energy contents or with a low fiber content can result in inadequate development of the birds' capacity for feed consumption, leading to low feed intakes and egg-production during lay.

Pre-Lay Diets

The recommended calcium content in the pullet diet is around 1%, which ensures sufficient calcium consumption to develop a good bone structure. The pre-lay diet, fed for 2 weeks prior to the first egg, but never earlier than 15 weeks of age, should contain higher levels of calcium (2.50% calcium) and phosphorus than the grower diets in an effort to help develop medullary bone. This type of bone acts as a calcium reservoir, from which the mature hen can quickly mobilize calcium for eggshell formation. Proper development of medullary bone has implications for osteoporosis and eggshell quality in late lay. Nevertheless, the extra management of a pre-lay diet, which is fed for only a short time, may preclude its use. In these cases, it is not recommended to feed a layer-type diet with high (4–5%) calcium prior to sexual maturity (i.e., instead of a pre-layer diet), because it can lead to wet manure, which persist well into the lay period. On the other hand, the grower and pre-lay diets should not be fed beyond the first egg, as they contain inadequate amounts of calcium for sustained egg production.

Nutritional Recommendations

Feeding the Laying Hen

A phase-feeding program should be practiced to ensure correct nutrient consumption throughout lay in order to match performance demands and to control egg size. The diets should be formulated according to the actual feed consumption rate and level of desired production. The number of feedings per day is important as a feed management tool, but careful depth control in the feed trough is essential to avoid feed waste. Hens should have access to feed at all times, especially immediately prior to the dark period.

The hens' feed consumption rate is governed by several factors, including body weight (or age), rate of egg production, egg weight, effective ambient temperature, feed texture, dietary nutrient imbalances, and dietary energy content. The latter is especially important, because hens tend to increase or decrease feed consumption to maintain energy intake—in other words, hens will consume more of a low-energy diet than of a high-energy diet. Only in special cases (such as nutrient imbalances or salt deficiencies) will the hens adjust their feed consumption to meet their needs for specific nutrients, but usually not with great accuracy.

A range of recommended energy concentrations is provided to accommodate several situations where diets of different densities are needed or to accommodate changes in feed-energy costs. As a general rule, the energy concentration at the low end of the recommended range corresponds to the higher feed consumption rates. Increased energy and nutrient density of the feed is useful at certain times, especially when energy consumption may be a limiting factor, such as the critical period between housing and peak production. Flocks consuming less than 270–280 kcal/day (1.13–1.17 MJ/day) per bird at peak production tend to suffer post-peak dips in production and reduced egg size. Heat stress will also result in lower feed and energy consumption. As a result, increasing the energy content in the feed can result in better body weight gain, egg production, and egg weight, especially when the effective ambient temperature is high. Fats or oils are concentrated sources of energy and can be useful in increasing the energy content of feed. The digestion of fat produces less body heat (i.e., fat has a relatively low heat increment), which is useful during periods of heat stress. Moreover, vegetable oils are typically high in linoleic acid, which generally benefits egg weight, although a blend of vegetable oil and animal fat may also be acceptable.

Formulating for Feed Intake

Accurate and frequent estimates of actual flock feed intake are critical to effective feed formulation. Because the hens' feed consumption rate can vary with age of the bird, effective ambient temperature, and dietary energy content, the diet's concentration of energy and nutrients should be carefully considered such that the diet provides the recommended nutrient intake. For example, with an observed feed consumption of 95 g/day and a recommended daily calcium intake of 4.10 g/day, the dietary calcium concentration should be 4.32%:

$$\frac{4.10 \text{ g calcium needed} \times 100}{95 \text{ g feed consumed}} = 4.32\% \text{ calcium in the diet}$$

Similarly, if the recommended digestible lysine consumption is 750 mg/day, the dietary concentration of digestible lysine should be 0.789%:

$$\frac{750 \text{ mg digestible lysine needed} \times 100}{95 \text{ g feed consumed}} = 0.789\% \text{ digestible lysine in the diet}$$

Should the daily feed consumption decrease to, say, 85 g/day (for instance due to increased effective ambient temperature or an increase in the dietary energy concentration), the hens fed the above diet would consume only (85 g × 4.32% =) 3.67 g calcium and (85 g × 0.789% =) 671 mg digestible lysine, which is significantly less than the recommended amounts. As a result, eggshell quality, egg weight, and egg production will decrease. Therefore, with a feed consumption of 85 g/day, the dietary concentrations of calcium and digestible lysine should be adjusted to 4.82% and 0.882%, respectively, to ensure the recommended calcium and digestible-lysine intakes of 4.10 g and 750 mg, respectively:

$$\frac{4.10 \text{ g calcium needed} \times 100}{85 \text{ g feed consumed}} = 4.82\% \text{ calcium in the diet}$$

$$\frac{750 \text{ mg digestible lysine needed} \times 100}{85 \text{ g feed consumed}} = 0.882\% \text{ digestible lysine in the diet}$$

Nutrition and Egg Weight

Body weight at point of lay influences yolk size, which, in turn, influences egg weight. Therefore, changing the pullet feeding and management program to increase body weight at point of lay can increase the egg size throughout the laying period and vice versa. During the laying period, egg weight can be controlled to some degree by changing the consumption of balanced protein or individual amino acids (of these, methionine has traditionally been used to affect egg weight), linoleic acid, and supplemental fat or oil. Although energy consumption can affect egg weight, it is difficult to manipulate energy consumption, because birds tend to regulate their feed consumption rate to meet their energy needs. Note that if these nutritional strategies are used to control egg weights to avoid excessively heavy eggs, it is important to start egg-weight control early in the production cycle—once the eggs are above the desired weights, it is difficult to make corrections without affecting egg production.

Nutrition and Eggshell Quality

Adequate consumption of calcium, phosphorus, trace minerals (e.g., zinc, magnesium, manganese, and copper), and vitamin D₃ is essential for eggshell quality. Bioavailabilities of the minerals vary greatly among feed ingredients and should be considered when formulating diets. Moreover, the particle size of the main calcium supplement (typically calcium carbonate) is important. At least 65% of the added calcium carbonate should have a mean particle size of 2–4 mm, while 35% of the added calcium carbonate should have a mean particle size less than 2 mm. The lower solubility of the large-particle-size calcium carbonate will ensure that there is calcium available in the intestines during dark hours, when the hens normally do not consume the calcium-rich feed.

Growing Period Nutritional Recommendations

Item ¹	Starter 1	Starter 2	Grower	Developer	Pre-lay ⁶
Feed to a body weight of	200 g	450 g	1070 g	1260 g	1400 g
Approximate age	0–3 weeks	4–6 weeks	7–12 weeks	13–15 weeks	16–17 weeks
Recommended concentration²					
Metabolizable energy, kcal/lb	1275–1325	1275–1325	1265–1315	1230–1280	1240–1330
Metabolizable energy, kcal/kg	2811–2922	2811–2922	2789–2900	2712–2822	2734–2933
Metabolizable energy, MJ/kg	11.77–12.23	11.77–12.23	11.68–12.14	11.35–11.81	11.44–12.28
Minimum recommended concentration					
Standardized (true) ileal digestible amino acids					
Lysine, %	0.99	0.90	0.80	0.65	0.70
Methionine, %	0.45	0.41	0.38	0.31	0.34
Methionine+cystine, %	0.75	0.70	0.65	0.57	0.63
Threonine, %	0.63	0.59	0.54	0.44	0.48
Tryptophan, %	0.18	0.17	0.17	0.14	0.15
Arginine, %	1.06	0.96	0.86	0.70	0.75
Isoleucine, %	0.69	0.65	0.59	0.49	0.56
Valine, %	0.71	0.67	0.62	0.52	0.60
Total amino acids ³					
Lysine, %	1.08	0.99	0.88	0.71	0.77
Methionine, %	0.48	0.45	0.40	0.33	0.37
Methionine+cystine, %	0.85	0.79	0.73	0.65	0.71
Threonine, %	0.75	0.69	0.63	0.52	0.57
Tryptophan, %	0.21	0.20	0.20	0.17	0.18
Arginine, %	1.14	1.04	0.92	0.75	0.81
Isoleucine, %	0.75	0.70	0.64	0.52	0.60
Valine, %	0.79	0.73	0.69	0.57	0.66
Crude protein (nitrogen × 6.25), ³ %	20.00	18.25	17.50	16.00	16.50
Calcium, ⁴ %	1.00	1.00	1.00	1.40	2.50
Phosphorus (available), ⁵ %	0.45	0.44	0.43	0.45	0.48
Sodium, %	0.18	0.17	0.17	0.18	0.18
Chloride, %	0.18	0.17	0.17	0.18	0.18
Linoleic acid (C18:2 n-6), %	1.00	1.00	1.00	1.00	1.00

¹Change diets at the recommended target body weight—the approximate age is a guide only.

²Differences in the metabolizable energy value assigned to feed ingredients of the same name can differ substantially; in some cases, the recommended dietary energy content may have to be adjusted accordingly (see text).

³The minimum recommendations for total amino acids and crude protein are only appropriate with a corn and soybean meal diet; please formulate the diet on digestible amino acid basis instead.

⁴Calcium should be supplied as a fine calcium carbonate source (mean particle size less than 2 mm).

⁵Digestible phosphorus is sometimes preferred over available phosphorus. However, there are insufficient data available to make recommendations about a minimum dietary digestible-phosphorus content for Hy-Line birds. Instead, use the available-phosphorus recommendations and the available-phosphorus contents of feed ingredients (shown on the inside back cover of this guide).

⁶Do not feed the pre-lay diet beyond the first egg as it does not contain sufficient calcium to sustain egg production.

Growing Period Feed Consumption

age in weeks	Daily		Cumulative	
	g/day per bird	lb/day per 100 birds	g to date	lb to date
1	10	2.20	70	0.15
2	18	3.97	196	0.43
3	21	4.63	343	0.76
4	27	5.95	532	1.17
5	30	6.61	742	1.64
6	36	7.94	994	2.19
7	40	8.82	1274	2.81
8	43	9.48	1575	3.47
9	49	10.80	1918	4.23
10	54	11.90	2296	5.06
11	58	12.79	2702	5.96
12	62	13.67	3136	6.91
13	65	14.33	3591	7.92
14	68	14.99	4067	8.97
15	70	15.43	4557	10.05
16	75	16.53	5082	11.20
17	77	16.98	5621	12.39

Laying Period Nutritional Recommendations

Item ¹	Peaking	Above 93% to 89% egg production	88–85% egg production	Less than 85% egg production
	<i>Point of lay to 32 Weeks</i>	<i>33–44 Weeks</i>	<i>45–58 Weeks</i>	<i>59+ Weeks</i>
Recommended concentration²				
Metabolizable energy, kcal/lb	1260–1300	1240–1300	1215–1300	1160–1285
Metabolizable energy, kcal/kg	2778–2867	2734–2867	2679–2867	2558–2833
Metabolizable energy, MJ/kg	11.63–12.00	11.44–12.00	11.21–12.00	10.71–11.86
Minimum recommended concentration				
Standardized (true) ileal digestible amino acids				
Lysine, mg/day	850	840	800	750
Methionine, mg/day	417	412	392	368
Methionine+cystine, mg/day	714	722	688	645
Threonine, mg/day	595	588	560	525
Tryptophan, mg/day	179	176	168	158
Arginine, mg/day	910	899	856	803
Isoleucine, mg/day	672	664	632	593
Valine, mg/day	765	756	720	675
Total amino acids ³				
Lysine, mg/day	931	920	876	821
Methionine, mg/day	448	443	422	395
Methionine+cystine, mg/day	805	815	776	727
Threonine, mg/day	700	692	659	618
Tryptophan, mg/day	213	211	201	188
Arginine, mg/day	978	966	920	863
Isoleucine, mg/day	722	714	680	637
Valine, mg/day	844	834	794	744
Crude protein (nitrogen × 6.25), ³ g/day	17.00	16.75	16.00	15.50
Calcium, ⁴ g/day	4.00	4.40	4.70	4.90
Phosphorus (available), ⁵ mg/day	440	400	360	350
Sodium, mg/day	180	180	180	180
Chloride, mg/day	180	180	180	180
Linoleic acid (C18:2 n-6), g/day	1.00	1.00	1.00	1.00
Choline, mg/day	100	100	100	100

¹Consumption of crude protein, methionine+cystine, fat, linoleic acid, and/or energy may be changed to optimize egg size.

²The recommended energy range is based on the energy values shown in the table on the inside back cover of this guide. Differences in the metabolizable energy value assigned to feed ingredients of the same name can differ substantially; in some cases, the recommended dietary energy content may have to be adjusted accordingly (see text).

³Total amino acids are only appropriate with a corn and soybean diet; please formulate the diet on digestible amino acid basis if a substantial amount of other protein-supplying ingredients are used.

⁴Approximately 65% of the added calcium carbonate (limestone) should be in particle sizes of 2–4 mm.

⁵Digestible phosphorus is sometimes preferred over available phosphorus. However, there are insufficient data available to make recommendations about a minimum dietary digestible-phosphorus content for Hy-Line birds. Instead, use the available-phosphorus recommendations and the available-phosphorus contents of feed ingredients (shown on the inside back cover of this guide).

Laying Period Nutritional Recommendations

Peaking; point of lay to 32 weeks¹					
Recommended energy concentration: ² 1260–1300 kcal/lb, 2778–2867 kcal/kg, 11.63–12.00 MJ/kg					
Feed consumption, g/day per hen	93	98	103*	108	113
Feed consumption lb/day per 100 hens	20.5	21.6	22.7	23.8	24.9
Standardized (true) ileal digestible amino acids					
Lysine, %	0.91	0.87	0.83	0.79	0.75
Methionine, %	0.45	0.43	0.40	0.39	0.37
Methionine+cystine, %	0.77	0.73	0.69	0.66	0.63
Threonine, %	0.64	0.61	0.58	0.55	0.53
Tryptophan, %	0.19	0.18	0.17	0.17	0.16
Arginine, %	0.98	0.93	0.88	0.84	0.81
Isoleucine, %	0.72	0.69	0.65	0.62	0.59
Valine, %	0.82	0.78	0.74	0.71	0.68
Total amino acids ³					
Lysine, %	1.00	0.95	0.90	0.86	0.82
Methionine, %	0.48	0.46	0.43	0.41	0.40
Methionine+cystine, %	0.87	0.82	0.78	0.75	0.71
Threonine, %	0.75	0.71	0.68	0.65	0.62
Tryptophan, %	0.23	0.22	0.21	0.20	0.19
Arginine, %	1.05	1.00	0.95	0.91	0.87
Isoleucine, %	0.78	0.74	0.70	0.67	0.64
Valine, %	0.91	0.86	0.82	0.78	0.75
Crude protein (nitrogen × 6.25), ³ %	18.28	17.35	16.50	15.74	15.04
Calcium, ⁴ %	4.30	4.08	3.88	3.70	3.54
Phosphorus (avail.), ⁵ %	0.47	0.45	0.43	0.41	0.39
Sodium, %	0.19	0.18	0.17	0.17	0.16
Chloride, %	0.19	0.18	0.17	0.17	0.16
Linoleic acid (C18:2 n-6), %	1.08	1.02	0.97	0.93	0.88

*Typical feed consumption based on available data for the age in North America.

Above 93% to 89% egg production; 33–44 weeks¹					
Recommended energy concentration: ² 1240–1300 kcal/lb, 2734–2867 kcal/kg, 11.44–12.00 MJ/kg					
Feed consumption, g/day per hen	100	105	110*	115	120
Feed consumption lb/day per 100 hens	22.1	23.2	24.3	25.4	26.5
Standardized (true) ileal digestible amino acids					
Lysine, %	0.84	0.80	0.76	0.73	0.70
Methionine, %	0.41	0.39	0.37	0.36	0.34
Methionine+cystine, %	0.72	0.69	0.66	0.63	0.60
Threonine, %	0.59	0.56	0.53	0.51	0.49
Tryptophan, %	0.18	0.17	0.16	0.15	0.15
Arginine, %	0.90	0.86	0.82	0.78	0.75
Isoleucine, %	0.66	0.63	0.60	0.58	0.55
Valine, %	0.76	0.72	0.69	0.66	0.63
Total amino acids ³					
Lysine, %	0.92	0.88	0.84	0.80	0.77
Methionine, %	0.44	0.42	0.40	0.39	0.37
Methionine+cystine, %	0.82	0.78	0.74	0.71	0.68
Threonine, %	0.69	0.66	0.63	0.60	0.58
Tryptophan, %	0.21	0.20	0.19	0.18	0.18
Arginine, %	0.97	0.92	0.88	0.84	0.81
Isoleucine, %	0.71	0.68	0.65	0.62	0.60
Valine, %	0.83	0.79	0.76	0.73	0.70
Crude protein (nitrogen × 6.25), ³ %	16.75	15.95	15.23	14.57	13.96
Calcium, ⁴ %	4.40	4.19	4.00	3.83	3.67
Phosphorus (avail.), ⁵ %	0.40	0.38	0.36	0.35	0.33
Sodium, %	0.18	0.17	0.16	0.16	0.15
Chloride, %	0.18	0.17	0.16	0.16	0.15
Linoleic acid (C18:2 n-6), %	1.00	0.95	0.91	0.87	0.83

*Typical feed consumption based on available data for the age in North America.

¹Consumption of crude protein, methionine+cystine, fat, linoleic acid, and/or energy may be changed to optimize egg size.

²The recommended energy range is based on the energy values shown in the table on the inside back cover of this guide. Differences in the metabolizable energy value assigned to feed ingredients of the same name can differ substantially; in some cases, the recommended dietary energy content may have to be adjusted accordingly (see text).

³Total amino acids are only appropriate with a corn and soybean meal diet; please formulate the diet on digestible amino acid basis if a substantial amount of other protein-supplying ingredients are used.

⁴Approximately 65% of the added calcium carbonate (limestone) should be in particle sizes of 2–4 mm.

⁵Digestible phosphorus is sometimes preferred over available phosphorus. However, there are insufficient data available to make recommendations about a minimum dietary digestible-phosphorus content for Hy-Line birds. Instead, use the available-phosphorus recommendations and the available-phosphorus contents of feed ingredients (shown on the inside back cover of this guide).

Laying Period Nutritional Recommendations

88–85% egg production; 45–58 weeks¹					
Recommended energy concentration: ² 1215–1300 kcal/lb, 2679–2867 kcal/kg, 11.21–12.00 MJ/kg					
Feed consumption, g/day per hen	100	105	110*	115	120
Feed consumption lb/day per 100 hens	22.1	23.2	24.3	25.4	26.5
Standardized (true) ileal digestible amino acids					
Lysine, %	0.80	0.76	0.73	0.70	0.67
Methionine, %	0.39	0.37	0.36	0.34	0.33
Methionine+cystine, %	0.69	0.66	0.63	0.60	0.57
Threonine, %	0.56	0.53	0.51	0.49	0.47
Tryptophan, %	0.17	0.16	0.15	0.15	0.14
Arginine, %	0.86	0.82	0.78	0.74	0.71
Isoleucine, %	0.63	0.60	0.57	0.55	0.53
Valine, %	0.72	0.69	0.65	0.63	0.60
Total amino acids ³					
Lysine, %	0.88	0.83	0.80	0.76	0.73
Methionine, %	0.42	0.40	0.38	0.37	0.35
Methionine+cystine, %	0.78	0.74	0.71	0.67	0.65
Threonine, %	0.66	0.63	0.60	0.57	0.55
Tryptophan, %	0.20	0.19	0.18	0.17	0.17
Arginine, %	0.92	0.88	0.84	0.80	0.77
Isoleucine, %	0.68	0.65	0.62	0.59	0.57
Valine, %	0.79	0.76	0.72	0.69	0.66
Crude protein (nitrogen × 6.25), ³ %	16.00	15.24	14.55	13.91	13.33
Calcium, ⁴ %	4.70	4.48	4.27	4.09	3.92
Phosphorus (avail.), ⁵ %	0.36	0.34	0.33	0.31	0.30
Sodium, %	0.18	0.17	0.16	0.16	0.15
Chloride, %	0.18	0.17	0.16	0.16	0.15
Linoleic acid (C18:2 n-6), %	1.00	0.95	0.91	0.87	0.83

**Typical feed consumption based on available data for the age in North America.*

Less than 85% egg production; 59+ weeks¹					
Recommended energy concentration: ² 1160–1285 kcal/lb, 2558–2833 kcal/kg, 10.71–11.86 MJ/kg					
Feed consumption, g/day per hen	99	104	109*	114	119
Feed consumption lb/day per 100 hens	21.8	22.9	24.0	25.1	26.2
Standardized (true) ileal digestible amino acids					
Lysine, %	0.76	0.72	0.69	0.66	0.63
Methionine, %	0.37	0.35	0.34	0.32	0.31
Methionine+cystine, %	0.65	0.62	0.59	0.57	0.54
Threonine, %	0.53	0.50	0.48	0.46	0.44
Tryptophan, %	0.16	0.15	0.14	0.14	0.13
Arginine, %	0.81	0.77	0.74	0.70	0.67
Isoleucine, %	0.60	0.57	0.54	0.52	0.50
Valine, %	0.68	0.65	0.62	0.59	0.57
Total amino acids ³					
Lysine, %	0.83	0.79	0.75	0.72	0.69
Methionine, %	0.40	0.38	0.36	0.35	0.33
Methionine+cystine, %	0.73	0.70	0.67	0.64	0.61
Threonine, %	0.62	0.59	0.57	0.54	0.52
Tryptophan, %	0.19	0.18	0.17	0.16	0.16
Arginine, %	0.87	0.83	0.79	0.76	0.73
Isoleucine, %	0.64	0.61	0.58	0.56	0.54
Valine, %	0.75	0.72	0.68	0.65	0.63
Crude protein (nitrogen × 6.25), ³ %	15.66	14.90	14.22	13.60	13.03
Calcium, ⁴ %	4.95	4.71	4.50	4.30	4.12
Phosphorus (avail.), ⁵ %	0.35	0.34	0.32	0.31	0.29
Sodium, %	0.18	0.17	0.17	0.16	0.15
Chloride, %	0.18	0.17	0.17	0.16	0.15
Linoleic acid (C18:2 n-6), %	1.01	0.96	0.92	0.88	0.84

**Typical feed consumption based on available data for the age in North America.*

¹Consumption of crude protein, methionine+cystine, fat, linoleic acid, and/or energy may be changed to optimize egg size.

²The recommended energy range is based on the energy values shown in the table on the inside back cover of this guide. Differences in the metabolizable energy value assigned to feed ingredients of the same name can differ substantially; in some cases, the recommended dietary energy content may have to be adjusted accordingly (see text).

³Total amino acids are only appropriate with a corn and soybean meal diet; please formulate the diet on digestible amino acid basis if a substantial amount of other protein-supplying ingredients are used.

⁴Approximately 65% of the added calcium carbonate (limestone) should be in particle sizes of 2–4 mm.

⁵Digestible phosphorus is sometimes preferred over available phosphorus. However, there are insufficient data available to make recommendations about a minimum dietary digestible-phosphorus content for Hy-Line birds. Instead, use the available-phosphorus recommendations and the available-phosphorus contents of feed ingredients (shown on the inside back cover of this guide).

Added Trace Minerals and Vitamins

Item ^{1,2}	Growing Period		Laying Period	
	In 1000 kg complete diet	In 2000 lb complete diet	In 1000 kg complete diet	In 2000 lb complete diet
Added minerals per ton				
Manganese, g	88	80	88	80
Zinc, g	88	80	88	80
Iron, g	55	50	55	50
Copper, g	11.0	10.0	5.5	5.0
Iodine, g	1.7	1.5	1.7	1.5
Selenium, g	0.30	0.27	0.30	0.27
Added vitamins per ton				
Vitamin A, IU	9,900,000	9,000,000	8,800,000	8,000,000
Vitamin D ₃ , IU	3,300,000	3,000,000	3,300,000	3,000,000
Vitamin E, IU	22,100	20,000	16,500	15,000
Vitamin K (menadione), g	3.3	3.0	2.2	2.0
Thiamine (B ₁), g	2.2	2.0	1.7	1.5
Riboflavin (B ₂), g	6.6	6.0	5.5	5.0
Niacin (B ₃), g	33	30	28	25
Pantothenic acid (B ₅), g	11.0	10.0	6.6	6.0
Pyridoxine (B ₆), g	4.4	4.0	3.3	3.0
Biotin (B ₇), mg	55	50	55	50
Folic acid (B ₉), g	0.9	0.8	0.6	0.5
Cobalamine (B ₁₂), mg	22.1	20.0	22.1	20.0
Choline, g	110	100	110	100

¹Minimum recommendations.

²Local regulations may limit the dietary content of individual minerals or vitamins.

Water Consumption

Water is the most important nutrient and good-quality water must be available to the birds at all times. Only in special cases (e.g., prior to vaccine delivery through the drinking water), should drinking water be restricted, and then only for a short time. Water and feed consumption are directly related—when birds drink less, they consume less feed, and production quickly declines accordingly.

As a general rule, healthy birds will consume twice as much water as feed, although the ratio increases during periods of high ambient temperatures. In some cases, high concentrations of minerals (e.g., sodium) in the water should lead to changes in the dietary composition.

Water Consumption for Hy-Line Brown Pullets and Layers Water Consumed per 100 Birds per Day

Chicks should consume 0.83 liters (0.22 gallons) per 100 birds on day one of age.

Age in Weeks	Liters	Gallons	Age in Weeks	Liters	Gallons
1	0.8–1.1	0.20–0.30	8	6.1–8.0	1.60–2.10
2	1.1–1.9	0.30–0.50	9	6.4–9.5	1.70–2.50
3	1.7–2.7	0.45–0.70	10–15	6.8–10.2	1.80–2.70
4	2.5–3.8	0.65–1.00	16–20	7.2–15.2	1.90–4.00
5	3.4–4.7	0.90–1.25	21–25*	9.9–18.2	2.60–4.80
6	4.5–5.7	1.20–1.50	Over 25*	15.2–20.8	4.00–5.50
7	5.7–6.8	1.50–1.80			

**Higher temperatures tend to elevate water consumption by 1.9 liters (0.5 gallons) per 100 birds.*

Ventilation

Ventilation should be used as a major management tool to provide the optimum micro-environment. It is essential to provide each bird with an adequate supply of oxygen and to remove carbon dioxide produced by the birds and dust particles that have become aerosolized. Controlled ventilation can do a great deal to dilute pathogenic organisms as well as provide an optimum environment when ventilation equipment is designed and operated to give correct air speed and direction.

The house temperature and humidity should be in the range of 18–27°C (65–80°F) and 40–60% humidity. A general rule for determining required fan capacity is 4 m³ of air movement per kilogram of body weight per hour (1 ft³ per minute per pound of body weight).

Suggested Minimum Ventilation Rates

Cubic Feet Per Minute Per Bird							Cubic Meters Per Hour Per Bird						
Age of Birds							Age of Birds						
Outside Temperature	First Week	3 Wks.	6 Wks.	12 Wks.	18 Wks.	Beyond 18 Wks.	Outside Temperature	First Week	3 Wks.	6 Wks.	12 Wks.	18 Wks.	Beyond 18 Wks.
90°F	1.0	1.5	2.0	3.0	4.0	6.0–7.0	32°C	1.7	2.5	3.4	5.1	6.8	10.2–11.9
70°F	0.7	1.0	1.5	2.0	3.0	4.0–5.0	21°C	1.2	1.7	2.5	3.4	5.1	6.8–8.5
50°F	0.4	0.7	1.0	1.5	2.0	2.5–3.0	10°C	0.7	1.2	1.7	2.5	3.4	4.2–5.1
32°F	0.3	0.5	0.7	1.0	1.5	2.0–2.5	0°C	0.5	0.8	1.2	1.7	2.5	3.4–4.2
10°F	0.2	0.3	0.5	0.7	1.0	1.5–2.0	–12°C	0.3	0.5	0.8	1.2	1.7	2.5–3.4
–10°F	0.1	0.2	0.3	0.5	0.5	1.0–1.5	–23°C	0.2	0.3	0.5	0.8	0.8	1.7–2.5

Recommended Cage Densities for the Hy-Line Brown Layer

	European Union Guidelines	U.S. Recommended (United Egg Producers)
Cage Space	450–550 cm ² (70–85 sq in)	432–555 cm ² (67–86 sq in)
Feeder Space	10 cm/bird (4 in/bird)	7.6 cm/bird (3 in/bird)
Water Space	access to 2 cups or nipples/cage	2 cups or nipples/12 birds or 1 in trough/bird

Non-Fast Molting

Many producers are now using programs to induce molting which do not involve fasting of the birds because of welfare concerns. The Hy-Line Brown bird will perform very well after a rest, particularly in the latter weeks of the molt cycle with excellent shell quality and persistency. The optimum age for molting is usually 65 weeks.

Induced molting can extend the productive life of a flock by improving rate of lay, shell quality and albumen height. However, these levels will be somewhat lower than the best premolt values. Egg size will remain essentially unaffected and will continue to increase after production resumes.

A flock can be induced to cease laying by a variety of methods. A welfare oriented non-fast molting method has been developed that results in post molt performance equivalent to that from fasting methods. Free access to water at all times during the non-fast molt is essential. It is important to know the sodium content of the drinking water. High sodium levels, 100 ppm+, can negate this type of molt program. Contact Hy-Line Technical Services for details.

Non-Fast Molting Recommendations

Molt Day	Light Hours	Feed Type	Feed Modification ¹	Feed Intake ² g/day per bird (lb/day per 100 birds)	House Temperature ³	Comments
-7 to -5	16	Layer	Fine Lime	Full Feed	24–25°C (75–77°F)	Fine Lime Diet: Remove all coarse limestone and replace with fine limestone. DO NOT change the % calcium in the diet.
-4 to -1	24	Layer	Fine Lime/ No Added Salt	Full Feed	24–25°C (75–77°F)	
0	6–8 ⁴	Molt 1 ⁵	See Molt 1 diet	54–64 (12–14)	27–28°C (80–82°F)	Lower house temperatures may be needed to reduce body weight to 1.48–1.52 kg (3.3–3.4 lb).
1	6–8	Molt 1	Crude Fiber 12%	54–64 (12–14)	27–28°C (80–82°F)	
2	6–8	Molt 1		54–64 (12–14)	27–28°C (80–82°F)	
3	6–8	Molt 1		54–64 (12–14)	27–28°C (80–82°F)	
4	6–8	Molt 1		54–64 (12–14)	27–28°C (80–82°F)	
5	6–8	Molt 1		54–64 (12–14)	27–28°C (80–82°F)	
6	6–8	Molt 1		54–64 (12–14)	27–28°C (80–82°F)	
7 to 23	6–8	Molt 1		54–64 (12–14)	27–28°C (80–82°F)	Maintain 1.48–1.52 kg (3.3–3.4 lb) body weight.
24 to 30	13	Molt 2		Full Feed	26–27°C (78–80°F)	Lower house temperatures as needed to increase feed consumption.
31 to 38 ⁶	14	Molt 3		Full Feed	24–25°C (75–77°F)	
39+	15	Layer		Full Feed ⁷		

¹Probiotic or complex carbohydrate at 1 lb per ton (0.5 kg per metric ton) through all stages of the molt program.

²Feed intake depends on house temperature. Colder house temperatures may require more feed.

³Depends on air quality in the house. House temperatures may not be obtainable in cold weather.

⁴Set lights at 8 hours or natural day length in open-sided houses.

⁵Molt 1 feed is high fiber and no added salt.

⁶Increase lights 1 hour per week, up to 16 hours, starting on Day 28.

⁷According to diets in following table.

Post-Molt Nutritional Recommendations

Recommended concentration ¹	Molt 1	Molt 2	Molt 3
Metabolizable energy, kcal/lb	1179–1270	1247–1277	1281–1315
Metabolizable energy, kcal/kg	2600–2800	2750–2815	2825–2900
Metabolizable energy, MJ/kg	10.88–11.72	11.51–11.78	11.82–12.14
Minimum recommended concentration			
Standardized (true) digestibility			
Lysine, %	0.30	0.64	0.68
Methionine, %	0.15	0.39	0.33
Methionine+cystine, %	0.32	0.61	0.53
Threonine, %	0.18	0.41	0.43
Tryptophan, %	0.10	0.12	0.13
Arginine, %	0.38	0.79	0.82
Isoleucine, %	0.18	0.39	0.41
Valine, %	0.23	0.50	0.53
Total amino acids²			
Lysine, %	0.33	0.70	0.74
Methionine, %	0.16	0.42	0.36
Methionine+cystine, %	0.36	0.69	0.60
Threonine, %	0.21	0.48	0.50
Tryptophan, %	0.12	0.15	0.15
Arginine, %	0.41	0.85	0.88
Isoleucine, %	0.20	0.42	0.45
Valine, %	0.26	0.55	0.59
Crude protein (nitrogen × 6.25), ² %	8.50	15.50	16.50
Calcium, ³ %	1.30	2.85	4.00
Phosphorus (avail.), ⁴ %	0.25	0.47	0.47
Sodium, ⁵ %	0.03	0.18	0.18
Chloride, %	0.03	0.18	0.18

¹The recommended energy range is based on the energy values shown in the table on the inside back cover of this guide. Differences in the metabolizable energy value assigned to feed ingredients of the same name can differ substantially; in some cases, the recommended dietary energy content may have to be adjusted accordingly (see text).

²Total amino acids are only appropriate with a corn and soybean meal diet; please formulate the diet on digestible amino acid basis if a substantial amount of other protein-supplying ingredients are used.

³The added calcium carbonate (limestone) should be in particle sizes of less than 2 mm.

⁴Digestible phosphorus is sometimes preferred over available phosphorus. However, there are insufficient data available to make recommendations about a minimum dietary digestible-phosphorus content for Hy-Line birds. Instead, use the available-phosphorus recommendations and the available-phosphorus contents of feed ingredients (shown on the inside back cover of this guide).

⁵The sodium content in the Molt-1 diet should not exceed 0.035%.

Post-Molt Nutritional Recommendations

After the Molt-3 diet, formulate diets according to level of desired percentage egg production following the nutritional recommendations for first-cycle laying hens (see pages 23–26), albeit with a 20 kcal/kg (10 kcal/lb, 0.10 MJ/kg) reduction in the dietary energy content. Other noticeable differences in the post-molt diets are an increased need for dietary calcium and a decreased need for dietary phosphorus, reflected in the table.

Minimum recommended daily consumption	Peaking	Above 93% to 89% egg production	88–85% egg production	Less than 85% egg production
Calcium, g/day	4.70	4.90	5.10	5.30
Phosphorus (avail.), mg/day	440	400	360	320

Recommended post-molt dietary calcium and available phosphorus contents.					
Peaking					
Feed consumption, g/day per hen	93	98	103*	108	113
Feed consumption, lb/day per 100 hens	20.5	21.6	22.7*	23.8	24.9
Calcium, ¹ %	5.05	4.80	4.56	4.35	4.16
Phosphorus (avail.), ² %	0.47	0.45	0.43	0.41	0.39
Above 93% to 89% egg production					
Feed consumption, g/day per hen	100	105	110*	115	120
Feed consumption, lb/day per 100 hens	22.1	23.2	24.3*	25.4	26.5
Calcium, ¹ %	4.90	4.67	4.45	4.26	4.08
Phosphorus (avail.), ² %	0.40	0.38	0.36	0.35	0.33
88–85% egg production					
Feed consumption, g/day per hen	100	105	110*	115	120
Feed consumption, lb/day per 100 hens	22.1	23.2	24.3*	25.4	26.5
Calcium, ¹ %	5.10	4.86	4.64	4.43	4.25
Phosphorus (avail.), ² %	0.36	0.34	0.33	0.31	0.30
Less than 85% egg production					
Feed consumption, g/day per hen	99	104	109*	114	119
Feed consumption, lb/day per 100 hens	21.8	22.9	24.0*	25.1	26.2
Calcium, ¹ %	5.35	5.10	4.86	4.65	4.45
Phosphorus (avail.), ² %	0.32	0.31	0.29	0.28	0.27

*Typical feed consumption based on available data.

¹Approximately 65% of the added calcium carbonate (limestone) should be in particle sizes of 2–4 mm.

²Digestible phosphorus is sometimes preferred over available phosphorus. However, there are insufficient data available to make recommendations about a minimum dietary digestible-phosphorus content for Hy-Line birds. Instead, use the available-phosphorus recommendations and the available-phosphorus contents of feed ingredients (shown on the inside back cover of this guide).

Hy-Line Variety Brown Performance Table

Age in Weeks	% Hen-Day		Mortality	Hen-Day Eggs		Hen-Housed Eggs		Body Weight		Average Egg Weight*		Feed Consumption		Hen-Housed Egg Mass Cum.**		Egg Quality		
	Curr. under Opt. Conditions	Curr. under Avg. Conditions		% Cum.	Cum. under Opt. Conditions	Cum. under Avg. Conditions	Cum. under Opt. Conditions	Cum. under Avg. Conditions	kg	lb	g/egg	Net lb/30 doz case	g/day per bird	lb/day per 100 birds	kg	lb	Haugh Units	Breaking Strength
18	9	3	0.04	0.6	0.2	0.6	0.2	1.48	3.26	46.2	36.7	78	17.2	0.01	0.02	98.2	4620	90
19	16	11	0.1	1.8	1.0	1.7	1.0	1.53	3.37	46.6	37.0	80	17.6	0.05	0.10	98.0	4610	90
20	49	30	0.1	5.2	3.1	5.2	3.1	1.65	3.64	47.6	37.8	89	19.6	0.1	0.3	97.8	4605	89
21	69	54	0.2	10.0	6.9	10.0	6.8	1.72	3.79	49.3	39.1	93	20.5	0.3	0.7	97.2	4595	89
22	87	78	0.3	16.1	12.3	16.1	12.3	1.78	3.92	51.4	40.8	96	21.2	0.6	1.3	97.0	4590	89
23	91	87	0.3	22.5	18.4	22.4	18.4	1.80	3.97	54.4	43.2	100	22.1	0.9	2.1	96.5	4585	89
24	94	90	0.4	29.1	24.7	29.0	24.6	1.84	4.06	56.0	44.4	103	22.6	1.3	2.9	96.0	4580	89
25	95	91	0.4	35.7	31.1	35.6	31.0	1.85	4.08	57.4	45.6	104	22.9	1.7	3.7	95.5	4575	88
26	96	92	0.5	42.4	37.5	42.3	37.4	1.86	4.10	58.5	46.4	105	23.1	2.0	4.5	95.1	4570	88
27	96	93	0.6	49.1	44.0	48.9	43.9	1.88	4.15	59.2	47.0	106	23.4	2.4	5.3	94.7	4565	88
28	95	94	0.6	55.8	50.6	55.6	50.4	1.89	4.17	59.8	47.5	108	23.7	2.8	6.2	94.2	4560	88
29	95	94	0.7	62.4	57.2	62.2	56.9	1.90	4.19	60.2	47.8	108	23.8	3.2	7.1	93.7	4550	88
30	95	93	0.7	69.1	63.7	68.8	63.4	1.91	4.21	61.1	48.5	108	23.9	3.6	7.9	93.3	4540	88
31	95	93	0.8	75.7	70.2	75.4	69.8	1.91	4.21	61.3	48.7	109	24.0	4.0	8.8	92.8	4525	88
32	94	92	0.9	82.3	76.7	81.9	76.2	1.91	4.21	61.6	48.9	109	24.1	4.4	9.7	92.2	4515	88
33	94	92	0.9	88.9	83.1	88.4	82.6	1.92	4.23	62.0	49.2	110	24.2	4.8	10.5	92.0	4505	88
34	94	91	1.0	95.5	89.5	94.9	88.9	1.92	4.23	62.2	49.4	110	24.3	5.2	11.4	91.5	4490	88
35	93	91	1.1	102.0	95.8	101.3	95.2	1.92	4.23	62.3	49.4	110	24.3	5.6	12.3	91.1	4475	87
36	93	91	1.1	108.5	102.2	107.8	101.5	1.92	4.23	62.4	49.5	110	24.3	6.0	13.1	90.6	4450	87
37	92	90	1.2	114.9	108.5	114.1	107.7	1.93	4.26	62.5	49.6	110	24.3	6.3	14.0	90.4	4440	87
38	92	90	1.3	121.4	114.8	120.5	113.9	1.93	4.26	62.6	49.7	110	24.3	6.7	14.8	90.0	4425	87
39	92	90	1.4	127.8	121.1	126.8	120.1	1.94	4.28	62.7	49.8	110	24.3	7.1	15.7	89.6	4415	87
40	91	90	1.5	134.2	127.4	133.1	126.3	1.94	4.28	62.8	49.8	110	24.3	7.5	16.6	89.3	4405	87
41	91	89	1.5	140.6	133.6	139.4	132.5	1.94	4.28	63.0	50.0	110	24.3	7.9	17.4	88.9	4390	87
42	91	89	1.6	146.9	139.9	145.6	138.6	1.94	4.28	63.0	50.0	110	24.3	8.3	18.3	88.5	4375	87
43	91	89	1.7	153.3	146.1	151.9	144.7	1.95	4.30	63.1	50.1	110	24.3	8.7	19.1	88.0	4365	87
44	89	89	1.8	159.5	152.3	158.0	150.8	1.95	4.30	63.1	50.1	110	24.2	9.1	20.0	87.8	4355	87
45	89	89	1.9	165.8	158.6	164.1	157.0	1.95	4.30	63.1	50.1	110	24.2	9.4	20.8	87.4	4340	87
46	89	88	2.0	172.0	164.7	170.2	163.0	1.95	4.30	63.2	50.2	110	24.2	9.8	21.7	87.1	4320	87
47	89	88	2.1	178.2	170.9	176.3	169.0	1.95	4.30	63.2	50.2	110	24.2	10.2	22.5	86.7	4310	87
48	88	88	2.2	184.4	177.0	182.4	175.0	1.95	4.30	63.3	50.2	110	24.2	10.6	23.3	86.4	4305	87
49	88	88	2.3	190.5	183.2	188.4	181.1	1.95	4.30	63.3	50.2	110	24.2	11.0	24.2	86.1	4295	86

*Egg weights after 40 weeks of age assume phase feeding of protein to limit egg size.

**Egg Mass based on Hen-Housed Eggs.

Hy-Line Variety Brown Performance Table

Age in Weeks	% Hen-Day		Mortality	Hen-Day Eggs		Hen-Housed Eggs		Body Weight		Average Egg Weight*		Feed Consumption		Hen-Housed Egg Mass Cum.**		Egg Quality		
	Curr. under Opt. Conditions	Curr. under Avg. Conditions		% Cum.	Cum. under Opt. Conditions	Cum. under Avg. Conditions	Cum. under Opt. Conditions	Cum. under Avg. Conditions	kg	lb	g/egg	Net lb/30 doz case	g/day per bird	lb/day per 100 birds	kg	lb	Haugh Units	Breaking Strength
50	88	88	2.4	196.7	189.4	194.4	187.1	1.95	4.30	63.4	50.3	110	24.2	11.3	25.0	85.6	4280	86
51	88	87	2.5	202.9	195.4	200.4	193.0	1.96	4.32	63.4	50.3	110	24.2	11.7	25.9	85.0	4265	86
52	87	87	2.6	209.0	201.5	206.3	198.9	1.96	4.32	63.4	50.3	110	24.2	12.1	26.7	85.0	4250	86
53	87	87	2.7	215.0	207.6	212.2	204.9	1.96	4.32	63.5	50.4	110	24.2	12.5	27.5	84.8	4240	86
54	87	86	2.8	221.1	213.6	218.2	210.7	1.96	4.32	63.5	50.4	110	24.2	12.8	28.3	84.6	4225	86
55	86	86	2.9	227.2	219.7	224.0	216.6	1.96	4.32	63.6	50.5	110	24.2	13.2	29.1	84.3	4210	86
56	86	86	3.0	233.2	225.7	229.8	222.4	1.96	4.32	63.6	50.5	110	24.2	13.6	30.0	84.0	4190	85
57	86	85	3.1	239.2	231.6	235.7	228.2	1.96	4.32	63.7	50.6	110	24.2	14.0	30.8	83.8	4180	85
58	85	85	3.3	245.1	237.6	241.4	233.9	1.96	4.32	63.7	50.6	110	24.2	14.3	31.6	83.1	4170	85
59	85	84	3.4	251.1	243.5	247.2	239.6	1.96	4.32	63.7	50.6	110	24.2	14.7	32.4	82.8	4160	85
60	84	84	3.5	257.0	249.3	252.8	245.3	1.97	4.34	63.8	50.6	110	24.1	15.0	33.2	82.6	4150	85
61	84	83	3.6	262.9	255.2	258.5	250.9	1.97	4.34	63.8	50.6	110	24.1	15.4	33.4	82.4	4140	84
62	84	83	3.7	268.7	261.0	264.2	256.4	1.97	4.34	63.9	50.7	110	24.1	15.8	34.8	82.2	4130	84
63	83	82	3.9	274.5	266.7	269.7	262.0	1.97	4.34	64.0	50.8	110	24.1	16.1	35.5	82.0	4120	84
64	83	82	4.0	280.4	272.4	275.3	267.5	1.97	4.34	64.0	50.8	110	24.1	16.5	36.3	81.9	4110	83
65	82	81	4.1	286.1	278.1	280.8	272.9	1.97	4.34	64.1	50.9	110	24.1	16.8	37.1	81.8	4095	83
66	82	81	4.2	291.8	283.8	286.3	278.3	1.97	4.34	64.2	51.0	109	24.1	17.2	37.8	81.6	4080	83
67	81	80	4.3	297.5	289.4	291.7	283.7	1.97	4.34	64.2	51.0	109	24.1	17.5	38.6	81.5	4070	82
68	80	80	4.5	303.1	295.0	297.1	289.0	1.97	4.34	64.3	51.0	109	24.1	17.9	39.4	81.5	4060	82
69	79	79	4.6	308.6	300.5	302.4	294.3	1.98	4.37	64.3	51.0	109	24.1	18.2	40.1	81.3	4050	82
70	79	78	4.7	314.2	306.0	307.6	299.5	1.98	4.37	64.4	51.1	109	24.1	18.5	40.9	81.1	4040	81
71	79	77	4.8	319.7	311.4	312.9	304.6	1.98	4.37	64.5	51.2	109	24.1	18.9	41.6	81.1	4030	81
72	78	76	5.0	325.2	316.7	318.1	309.7	1.98	4.37	64.5	51.2	109	24.1	19.2	42.3	81.0	4020	81
73	78	76	5.1	330.6	322.0	323.3	314.7	1.98	4.37	64.6	51.3	109	24.1	19.5	43.0	80.9	4010	80
74	77	75	5.2	336.0	327.3	328.4	319.7	1.98	4.37	64.6	51.3	109	24.1	19.8	43.7	80.8	4000	80
75	77	74	5.4	341.4	332.4	333.5	324.6	1.98	4.37	64.7	51.3	109	24.1	20.1	44.4	80.7	3995	80
76	77	74	5.5	346.8	337.6	338.6	329.5	1.98	4.37	64.7	51.3	109	24.1	20.5	45.1	80.5	3990	80
77	76	73	5.7	352.1	342.7	343.6	334.3	1.98	4.37	64.8	51.4	109	24.1	20.8	45.8	80.4	3985	80
78	75	72	5.8	357.4	347.8	348.5	339.1	1.98	4.37	64.8	51.4	109	24.0	21.1	46.5	80.2	3980	80
79	74	71	6.0	362.5	352.7	353.4	343.7	1.98	4.37	64.9	51.5	109	24.0	21.4	47.2	80.1	3975	80
80	74	71	6.1	367.7	357.7	358.2	348.4	1.98	4.37	65.0	51.6	109	24.0	21.7	47.8	80.0	3970	80

*Egg weights after 40 weeks of age assume phase feeding of protein to limit egg size.

**Egg Mass based on Hen-Housed Eggs.



Hy-Line
BRAND
LAYERS

Hy-Line Brown Hen-Day Performance Graph

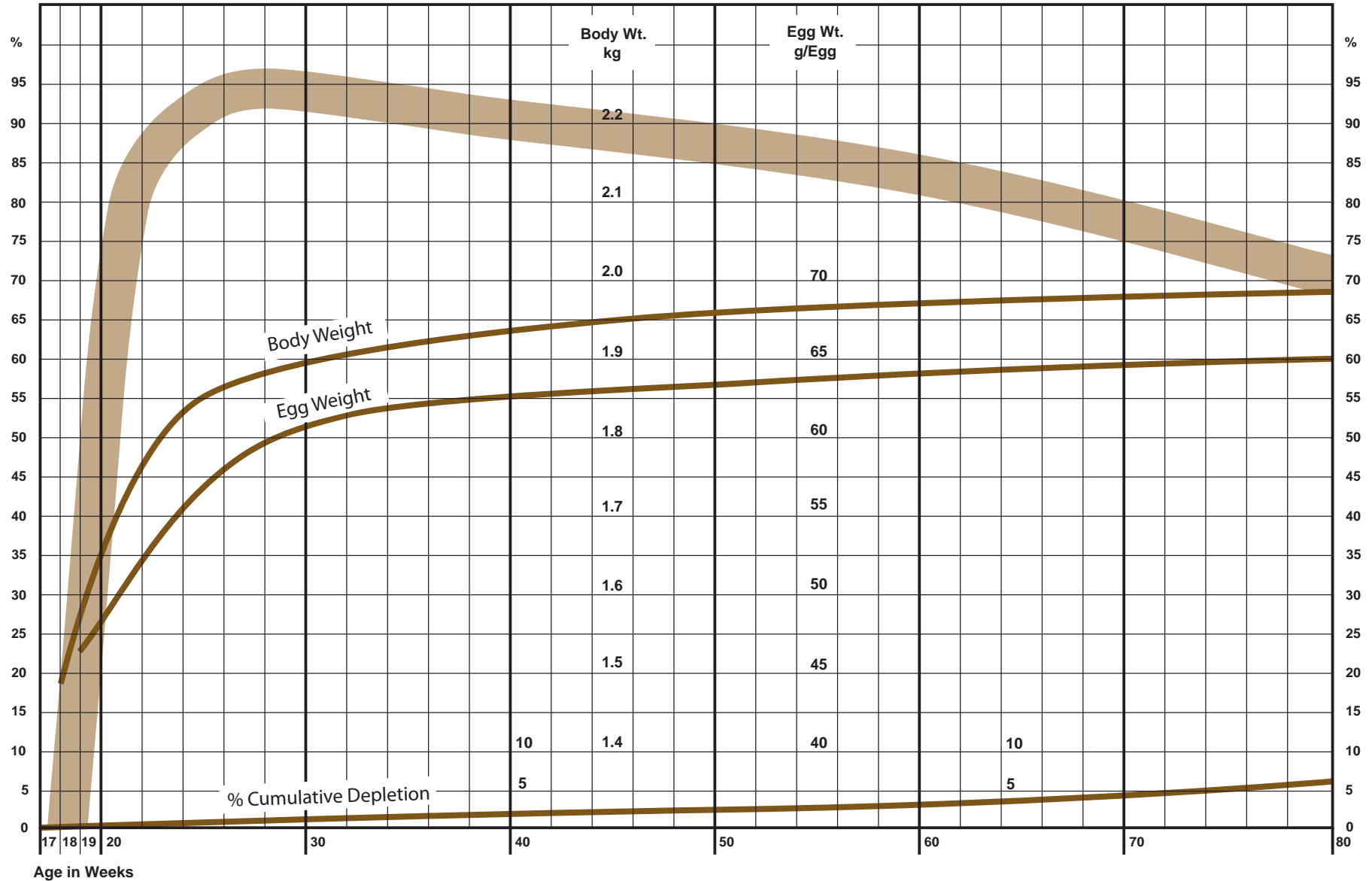

Hy-Line Variety Brown Post-Molt Performance Table

Age in Weeks	% Hen-Day Lay Curr.	% Mortality Cum.	Hen-Day Cum.	Hen-Housed Cum.	Body Weight		Average Egg Weight*		Feed Consumption		Hen-Housed** Egg Mass Cum.	
					kg	lb	g/egg	Net lb 30 doz case	g/day per bird	lb/day per 100 birds	kg	lb
					69	-	4.6	291.9	286.0	1.74	3.84	-
70	-	4.8	291.9	286.0	1.77	3.90	-	-	-	-	17.7	38.9
71	0	5.0	291.9	286.0	1.81	3.99	-	-	-	-	17.7	38.9
72	12	5.1	292.7	286.8	1.85	4.08	64.1	50.9	-	-	17.7	39.0
73	34	5.2	295.1	289.1	1.89	4.17	64.4	51.1	90	19.8	17.8	39.4
74	58	5.3	299.1	292.9	1.92	4.23	64.8	51.4	95	20.9	18.1	39.9
75	70	5.4	304.0	297.6	1.94	4.28	65.0	51.6	98	21.6	18.4	40.6
76	76	5.5	309.4	302.6	1.95	4.30	65.1	51.7	99	21.8	18.7	41.3
77	80	5.7	315.0	307.9	1.95	4.30	65.2	51.7	100	22.0	19.1	42.0
78	82	5.8	320.7	313.3	1.96	4.32	65.2	51.7	100	22.0	19.4	42.8
79	82	5.9	326.4	318.7	1.96	4.32	65.3	51.8	101	22.3	19.8	43.6
80	83	6.1	332.2	324.1	1.97	4.34	65.3	51.8	101	22.3	20.1	44.4
81	84	6.2	338.1	329.7	1.97	4.34	65.3	51.8	101	22.3	20.5	45.2
82	84	6.3	344.0	335.2	1.97	4.34	65.3	51.8	102	22.5	20.9	46.0
83	83	6.5	349.8	340.6	1.97	4.34	65.4	51.9	102	22.5	21.2	46.8
84	83	6.7	355.6	346.0	1.97	4.34	65.4	51.9	102	22.5	21.6	47.5
85	82	6.8	361.4	351.4	1.97	4.34	65.4	51.9	103	22.7	21.9	48.3
86	82	7.0	367.1	356.7	1.97	4.34	65.4	51.9	103	22.7	22.3	49.1
87	81	7.1	372.8	362.0	1.97	4.34	65.4	51.9	103	22.7	22.6	49.8
88	81	7.3	378.4	367.2	1.97	4.34	65.4	51.9	103	22.7	22.9	50.6
89	81	7.5	384.1	372.5	1.97	4.34	65.4	51.9	104	22.9	23.3	51.4
90	80	7.6	389.7	377.7	1.97	4.34	65.5	52.0	104	22.9	23.6	52.1
91	80	7.8	395.3	382.8	1.97	4.34	65.5	52.0	105	23.1	24.0	52.8
92	79	8.0	400.8	387.9	1.97	4.34	65.5	52.0	105	23.1	24.3	53.6
93	79	8.2	406.4	393.0	1.97	4.34	65.5	52.0	105	23.1	24.6	54.3
94	79	8.3	411.9	398.1	1.97	4.34	65.5	52.0	106	23.4	25.0	55.0
95	78	8.5	417.4	403.1	1.97	4.34	65.5	52.0	106	23.4	25.3	55.8

*These egg weights are those which can be achieved through controlled feeding of protein. Larger egg sizes can be achieved by feeding higher protein levels.

**Egg Mass based on Hen-Housed eggs.

Hy-Line Variety Brown Post-Molt Performance Table

Age in Weeks	% Hen-Day Lay Curr.	% Mortality Cum.	Hen-Day Cum.	Hen-Housed Cum.	Body Weight		Average Egg Weight *		Feed Consumption		Hen-Housed** Egg Mass Cum.	
					kg	lb	g/egg	Net lb 30 doz case	g/day per bird	lb/day 100 birds	kg	lb
					96	78	8.7	422.8	408.0	1.97	4.34	65.6
97	78	8.9	428.3	413.0	1.97	4.34	65.6	52.1	105	23.1	25.9	57.2
98	77	9.0	433.7	417.9	1.97	4.34	65.6	52.1	104	22.9	26.3	57.9
99	77	9.2	439.1	422.8	1.97	4.34	65.6	52.1	104	22.9	26.6	58.6
100	77	9.4	444.5	427.7	1.97	4.34	65.6	52.1	103	22.7	26.9	59.3
101	76	9.6	449.8	432.5	1.97	4.34	65.6	52.1	103	22.7	27.2	60.0
102	76	9.8	455.1	437.3	1.97	4.34	65.6	52.1	103	22.7	27.5	60.7
103	76	10.0	460.4	442.1	1.97	4.34	65.6	52.1	103	22.7	27.9	61.4
104	75	10.2	465.7	446.8	1.98	4.37	65.7	52.1	103	22.7	28.2	62.1
105	75	10.4	470.9	451.5	1.98	4.37	65.7	52.1	103	22.7	28.5	62.8
106	75	10.6	476.2	456.2	1.98	4.37	65.7	52.1	103	22.7	28.8	63.5
107	74	10.8	481.3	460.8	1.98	4.37	65.8	52.2	102	22.5	29.1	64.1
108	74	11.0	486.5	465.4	1.99	4.39	65.8	52.2	102	22.5	29.4	64.8
109	74	11.2	491.7	470.0	1.99	4.39	65.8	52.2	102	22.5	29.7	65.5
110	73	11.5	496.8	474.6	1.99	4.39	65.8	52.2	102	22.5	30.0	66.1

*These egg weights are those which can be achieved through controlled feeding of protein. Larger egg sizes can be achieved by feeding higher protein levels.

**Egg Mass based on Hen-Housed eggs.



Hy-Line Brown Hen-Day Performance Graph Molted Flocks

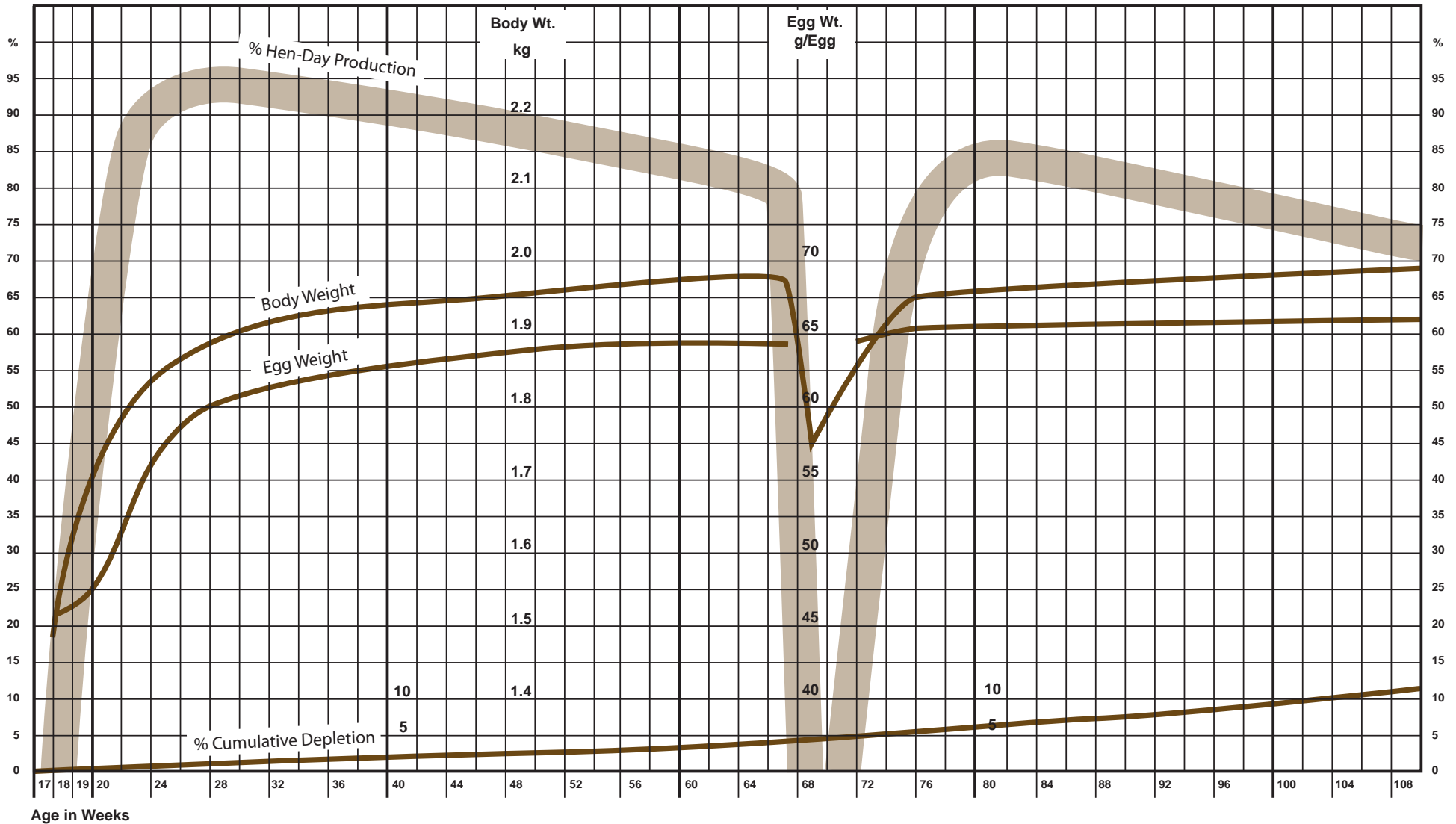

Egg Size Distribution—U.S. Standards

Age in Weeks	Average Egg Weight (lb/case)	Jumbo Over 30 oz/doz	Extra Large 27–30 oz/doz	Large 24–27 oz/doz	Medium 21–24 oz/doz	Small 18–21 oz/doz	Peewee Under 18 oz/doz
20	37.8	0.0	0.0	2.4	30.8	53.3	13.5
22	40.8	0.0	0.5	13.0	51.1	32.2	3.2
24	44.4	0.2	6.2	38.2	45.0	10.1	0.4
26	46.4	1.0	14.9	47.4	32.1	4.5	0.1
28	47.5	1.8	20.8	49.5	25.2	2.7	0.1
30	48.5	3.0	26.9	50.5	18.3	1.3	0.0
32	48.9	3.2	29.9	50.6	15.5	0.8	0.0
34	49.4	3.8	33.5	49.5	12.8	0.5	0.0
36	49.5	4.2	34.7	48.9	11.8	0.5	0.0
38	49.7	4.4	36.1	48.5	10.7	0.3	0.0
40	49.8	4.6	37.2	48.0	9.9	0.3	0.0
42	50.0	5.0	38.4	46.8	9.4	0.3	0.0
44	50.1	5.6	38.8	46.0	9.3	0.3	0.0
46	50.2	5.9	39.4	45.5	9.0	0.3	0.0
48	50.2	6.5	39.6	44.7	8.9	0.3	0.0
50	50.3	6.7	40.2	44.1	8.8	0.3	0.0
52	50.3	7.1	40.3	43.6	8.7	0.3	0.0
54	50.4	7.4	40.4	43.3	8.7	0.2	0.0
56	50.5	8.1	40.9	42.2	8.6	0.2	0.0
58	50.6	8.4	40.9	41.9	8.6	0.2	0.0
60	50.6	9.1	41.0	41.1	8.6	0.2	0.0
62	50.7	9.4	41.4	40.6	8.4	0.2	0.0
64	50.8	9.7	41.9	40.0	8.2	0.2	0.0
66	51.0	10.8	42.2	38.7	8.0	0.2	0.0
68	51.0	11.2	42.6	38.3	7.8	0.1	0.0
70	51.1	11.9	42.7	37.5	7.7	0.1	0.0
72	51.2	12.3	43.0	37.1	7.5	0.1	0.0
74	51.3	12.7	43.2	36.6	7.4	0.1	0.0
76	51.3	13.5	43.2	35.9	7.3	0.1	0.0
78	51.4	13.9	43.1	35.7	7.2	0.1	0.0
80	51.6	14.3	43.0	35.4	7.2	0.1	0.0

Egg Size Distribution—E.U. Standards

Age in Weeks	Average Egg Weight (g)	Very Large Over 73 g	Large 63–73 g	Medium 53–63 g	Small 43–53 g
20	47.6	0.0	0.0	12.0	88.0
22	51.4	0.0	0.8	36.2	63.1
24	56.0	0.0	8.5	63.7	27.8
26	58.5	0.3	19.5	65.2	15.0
28	59.8	0.6	26.7	62.7	10.0
30	61.1	1.1	34.6	58.3	6.0
32	61.6	1.1	37.8	56.8	4.3
34	62.2	1.4	42.1	53.5	3.0
36	62.4	1.5	43.6	52.1	2.8
38	62.6	1.6	45.0	51.3	2.1
40	62.8	1.7	46.7	49.6	2.1
42	63.0	1.9	48.1	48.0	2.0
44	63.1	2.2	48.7	47.2	2.0
46	63.2	2.3	49.4	46.5	1.9
48	63.3	2.6	49.8	45.7	1.9
50	63.4	2.7	50.5	44.9	1.9
52	63.4	2.9	50.5	44.7	1.9
54	63.5	3.1	50.8	44.2	1.9
56	63.6	3.5	51.4	43.2	1.8
58	63.7	3.7	51.7	42.8	1.8
60	63.8	4.1	51.9	42.2	1.8
62	63.9	4.3	52.4	41.5	1.8
64	64.0	4.5	53.0	40.7	1.8
66	64.2	5.2	53.6	39.5	1.7
68	64.3	5.4	54.2	38.8	1.7
70	64.4	5.9	54.2	38.2	1.7
72	64.5	6.1	54.6	37.5	1.7
74	64.6	6.3	55.1	36.9	1.7
76	64.7	6.9	55.1	36.3	1.7
78	64.8	7.2	55.0	36.1	1.7
80	65.0	8.0	55.0	35.3	1.7

Ingredient (as-fed basis)	Dry matter, %	Crude protein, %	Fat (ether extract), %	Crude fiber, %	Calcium, %	Phosphorus, total, %	Phosphorus, avail., %	Sodium, %	Chloride, %	Potassium, %	Sulfur, %	ME, kcal/lb	ME, kcal/kg	ME, MJ/kg	Linoleic acid, %	Choline, mg/kg
Alfalfa meal (17%), dehydrated	93.0	17.0	3.0	24.0	1.30	0.23	0.23	0.08	0.47	2.40	0.21	672	1482	6.20	-	1515
Barley	89.0	11.5	1.9	5.0	0.08	0.42	0.15	0.03	0.14	0.56	0.15	1250	2756	11.54	-	1027
Calcium carbonate (38% Ca)	99.5	-	-	-	38.00	-	-	0.06	-	0.06	-	-	-	-	-	-
Canola meal (38%)	91.0	38.0	3.8	11.1	0.68	1.17	0.30	-	-	1.29	1.00	960	2117	8.86	-	6701
Canola oil	99.0	-	99.0	-	-	-	-	-	-	-	-	4000	8820	36.92	20.50	-
Corn (maize)	87.0	7.9	3.5	1.9	0.01	0.25	0.09	0.02	0.04	0.30	0.08	1540	3396	14.21	1.75	1103
Corn DDGS	89.0	26.5	10.1	7.0	0.07	0.77	0.48	0.20	0.16	0.85	0.84	1256	2770	11.60	5.05	3254
Corn gluten feed (21%)	88.0	21.0	2.0	10.0	0.20	0.90	0.22	0.15	0.22	1.30	0.16	795	1753	7.34	-	2420
Corn gluten meal (60%)	90.0	60.0	2.0	2.5	0.02	0.50	0.18	0.03	0.05	0.45	0.50	1700	3749	15.69	-	2200
Cottonseed meal (41%), mech.	91.0	41.0	3.9	12.6	0.17	0.97	0.32	0.04	0.04	1.20	0.40	955	2106	8.81	-	2808
Cottonseed meal (41%), solv.	90.0	41.0	2.1	11.3	0.16	1.00	0.32	0.04	0.04	1.16	0.30	915	2018	8.45	-	2706
Dicalcium phosphate (18.5% P)	99.5	-	-	-	22.00	18.50	18.50	0.08	-	0.07	-	-	-	-	-	-
DL-Methionine	99.5	58.1	-	-	-	-	-	-	-	-	-	2277	5020	21.01	-	-
Fat, animal	99.0	-	98.0	-	-	-	-	-	-	-	-	3600	7938	33.23	-	-
Fat, animal-vegetable blend	98.0	-	92.0	-	-	-	-	-	-	-	-	3800	8379	35.07	30.00	-
Fat, vegetable	99.0	-	99.0	-	-	-	-	-	-	-	-	4000	8820	36.92	40.00	-
Fishmeal (62%), menhaden	92.0	62.0	9.2	1.0	4.80	3.00	3.00	0.68	0.80	0.96	0.45	1340	2955	12.37	-	3081
Fishmeal (65%), anchovy	91.0	65.0	10.0	1.0	4.00	2.85	2.85	0.88	0.60	0.90	0.54	1280	2822	11.81	-	5101
Flaxseed (linseed), whole	92.0	22.0	34.0	6.5	0.25	0.50	-	0.08	-	1.50	-	1795	3958	16.57	54.00	3150
Linseed (flax) meal (32%), exp.	90.0	32.0	3.5	9.5	0.40	0.80	-	0.11	-	1.24	0.39	700	1544	6.46	-	1672
Linseed (flax) meal (33%), solv.	88.0	33.0	0.5	9.5	0.35	0.75	-	0.14	-	1.38	0.39	635	1400	5.86	-	1760
L-Lysine-HCl	99.5	93.4	-	-	-	-	-	-	-	-	-	1868	4120	17.25	-	-
L-Threonine	99.5	72.4	-	-	-	-	-	-	-	-	-	1619	3570	14.94	-	-
L-Tryptophan	95.0	84.0	-	-	-	-	-	-	-	-	-	2653	5850	24.49	-	-
Meat and bone meal (50%)	93.0	50.0	8.5	2.8	9.20	4.70	4.70	0.73	0.75	1.40	0.40	1150	2536	10.61	-	2000
Molasses, cane	74.0	2.9	-	-	0.82	0.08	-	0.16	2.80	2.38	0.35	900	1985	8.31	-	660
Mono-dicalcium phosphate (21% P)	99.5	-	-	-	16.00	21.00	-	0.05	-	0.06	-	-	-	-	-	-
Oats	90.0	11.0	4.0	10.5	0.10	0.35	0.14	0.07	0.12	0.37	0.21	1160	2558	10.71	-	1070
Peanut meal (45%), mech.	92.0	45.0	5.0	12.0	0.15	0.55	0.18	-	0.03	1.15	0.28	-	-	-	-	1540
Peanut meal (48%), solv.	92.0	48.0	1.5	6.8	0.29	0.65	0.21	0.07	0.03	1.23	0.30	1000	2205	9.23	-	1948
Rapeseed meal (36%), solv.	92.0	36.0	2.6	13.2	0.66	0.93	0.30	0.09	-	-	-	805	1775	7.43	-	6714
Rice	89.0	7.3	1.7	10.0	0.04	0.26	0.09	0.04	0.06	0.34	0.10	1335	2944	12.32	-	1014
Rice bran	91.0	13.5	5.9	13.0	0.10	1.70	0.24	0.10	0.07	1.35	0.18	925	2040	8.54	-	1390
Rye	89.0	12.6	1.9	2.8	0.08	0.30	0.10	0.02	0.06	0.46	0.15	1230	2712	11.35	-	-
Safflower meal (20%), exp.	91.0	20.0	6.6	32.2	0.23	0.61	0.20	0.05	0.16	0.72	0.10	525	1158	4.85	-	800
Safflower meal (22%), solv.	90.0	22.0	0.5	37.0	0.34	0.84	0.23	0.05	0.16	0.72	0.10	680	1499	6.28	-	800
Salt, NaCl	99.6	-	-	-	-	-	-	39.34	60.66	-	-	-	-	-	-	-
Sesame meal (42%), exp.	94.0	42.0	7.0	6.5	2.00	1.30	0.24	0.04	0.06	1.39	0.40	1025	2260	9.46	-	1690
Sodium bicarbonate, NaHCO ₃	99.0	-	-	-	-	-	-	27.38	-	-	-	-	-	-	-	-
Sorghum, milo	89.0	11.0	2.8	2.0	0.04	0.29	0.10	0.03	0.09	0.34	0.09	1505	3319	13.89	-	678
Soybean meal (42%), exp.	89.0	42.0	3.5	6.5	0.20	0.60	0.20	0.04	0.02	1.71	0.33	1100	2426	10.15	-	2673
Soybean meal (44%), solv.	90.0	44.0	0.5	7.0	0.25	0.60	0.20	0.04	0.02	1.97	0.43	1020	2249	9.41	-	2743
Soybean meal (48%), solv.	88.0	47.8	1.0	3.0	0.20	0.65	0.21	0.04	0.02	1.90	0.43	1125	2481	10.38	-	2851
Soybean oil	99.0	-	99.0	-	-	-	-	-	-	-	-	4000	8820	36.92	40.00	-
Soybeans, full-fat, cooked	90.0	38.0	18.0	5.0	0.25	0.59	0.20	0.04	0.03	1.70	0.30	1520	3352	14.03	-	2420
Sunflower meal (41%), exp.	93.0	41.0	7.6	13.0	0.43	1.00	0.25	0.20	0.01	1.00	-	1050	2315	9.69	-	-
Sunflower meal (42%), solv.	93.0	42.0	2.3	13.0	0.40	1.00	0.25	0.20	0.01	1.00	-	800	1764	7.38	-	2901
Wheat bran	89.0	14.8	4.0	10.0	0.14	1.17	0.38	0.06	0.14	1.20	0.22	590	1301	5.45	-	980
Wheat middlings	89.0	15.0	3.6	8.5	0.15	0.91	0.28	0.06	0.07	0.60	0.16	950	2095	8.77	-	1100
Wheat, hard	88.0	13.5	1.9	3.0	0.05	0.41	0.12	0.06	0.07	0.50	0.10	1440	3175	13.29	-	778
Wheat, soft	86.0	10.8	1.7	2.8	0.05	0.30	0.11	0.06	0.07	0.40	0.10	1460	3219	13.48	-	778

Nutrient recommendations (pages 23–26) are based on calculations using these energy and nutrient values (source: Feedstuffs Magazine).

Ingredient (as-fed basis)	Crude protein, %	Lysine, %			Methionine, %			Cystine, %			Threonine, %			Tryptophan, %			Arginine, %			Isoleucine, %			Valine, %		
		Total content	Digestibility	Digestible content	Total content	Digestibility	Digestible content	Total content	Digestibility	Digestible content	Total content	Digestibility	Digestible content	Total content	Digestibility	Digestible content	Total content	Digestibility	Digestible content	Total content	Digestibility	Digestible content	Total content	Digestibility	Digestible content
Alfalfa meal (17%), dehydrated	17.0	0.73	59	0.43	0.28	73	0.20	0.18	40	0.07	0.75	71	0.53	0.45	75	0.34	0.75	87	0.65	0.84	77	0.65	1.04	75	0.78
Barley	11.5	0.53	88	0.47	0.18	88	0.16	0.25	88	0.22	0.36	85	0.31	0.17	69	0.12	0.50	85	0.43	0.42	90	0.38	0.62	85	0.53
Canola meal (38%)	38.0	2.30	80	1.84	0.70	84	0.59	0.47	77	0.36	1.71	73	1.25	0.44	80	0.35	2.30	87	2.00	1.51	79	1.19	1.94	79	1.53
Corn (maize)	7.9	0.24	92	0.22	0.18	94	0.17	0.18	87	0.16	0.29	85	0.25	0.07	81	0.06	0.40	93	0.37	0.29	95	0.28	0.42	92	0.39
Corn DDGS	26.5	0.73	75	0.55	0.50	86	0.43	0.54	77	0.42	0.96	72	0.69	0.21	80	0.17	0.96	73	0.70	0.96	84	0.80	1.30	81	1.05
Corn gluten feed (21%)	21.0	0.60	72	0.43	0.50	85	0.43	0.50	67	0.34	0.90	76	0.68	0.10	86	0.09	1.00	88	0.88	0.60	82	0.49	1.04	84	0.87
Corn gluten meal (60%)	60.0	1.00	76	0.76	1.90	88	1.67	1.10	78	0.86	2.00	79	1.58	0.30	66	0.20	1.90	86	1.63	2.30	86	1.98	2.70	85	2.30
Cottonseed meal (41%), mech.	41.0	1.52	65	0.99	0.55	72	0.40	0.59	74	0.44	1.30	68	0.88	0.50	80	0.40	4.33	88	3.81	1.31	71	0.93	1.84	74	1.36
Cottonseed meal (41%), solv.	41.0	1.70	65	1.11	0.51	72	0.37	0.62	74	0.46	1.34	68	0.91	0.52	80	0.42	4.66	88	4.10	1.33	71	0.94	1.82	74	1.35
DL-Methionine	58.1	-	-	-	99.00	100	99.00	-	-	-	-	-	-	-	-	-	-	-	-	-	-	-	-	-	-
Fishmeal (62%), menhaden	62.0	4.70	86	4.04	1.70	86	1.46	0.50	71	0.36	2.75	80	2.20	0.50	78	0.39	3.65	82	2.99	2.40	85	2.04	2.80	83	2.32
Fishmeal (65%), anchovy	65.0	4.90	86	4.21	1.90	86	1.63	0.60	71	0.43	2.70	80	2.16	0.75	78	0.59	3.38	82	2.77	3.00	85	2.55	3.40	83	2.82
Flaxseed (linseed), whole	22.0	0.92	90	0.83	0.35	79	0.28	0.42	80	0.34	0.77	91	0.70	0.22	89	0.20	2.05	92	1.89	0.95	88	0.84	1.17	86	1.01
Linseed (flax) meal (32%), exp.	32.0	1.10	87	0.96	0.47	82	0.39	0.56	73	0.41	1.10	-	-	0.47	-	-	2.60	95	2.47	1.70	86	1.46	1.50	83	1.25
Linseed (flax) meal (33%), solv.	33.0	1.10	87	0.96	0.48	82	0.39	0.58	73	0.42	1.20	-	-	0.48	-	-	2.70	95	2.57	1.80	86	1.55	1.60	83	1.33
L-Lysine-HCl	93.4	78.80	100	78.80	-	-	-	-	-	-	-	-	-	-	-	-	-	-	-	-	-	-	-	-	-
L-Threonine	72.4	-	-	-	-	-	-	-	-	98.50	100	98.50	-	-	-	-	-	-	-	-	-	-	-	-	-
L-Tryptophan	84.0	-	-	-	-	-	-	-	-	-	-	-	-	98.00	100	98.00	-	-	-	-	-	-	-	-	-
Meat and bone meal (50%)	50.0	2.60	81	2.11	0.67	85	0.57	0.33	58	0.19	1.70	79	1.34	0.26	78	0.20	3.35	84	2.81	1.70	84	1.43	2.25	83	1.87
Molasses, cane	2.9	-	-	-	-	-	-	-	-	-	-	-	-	-	-	-	-	-	-	-	-	-	-	-	-
Oats	11.0	0.40	87	0.35	0.20	87	0.17	0.21	84	0.18	0.28	84	0.24	0.18	80	0.14	0.80	94	0.75	0.53	89	0.47	0.62	88	0.55
Peanut meal (45%), mech.	45.0	1.55	76	1.18	0.41	86	0.35	0.68	79	0.54	1.40	85	1.19	0.46	87	0.40	4.70	91	4.28	1.80	89	1.60	2.60	89	2.31
Peanut meal (48%), solv.	48.0	1.77	-	-	0.42	-	-	0.73	-	-	1.16	-	-	0.50	-	-	4.55	-	-	1.76	-	-	1.88	-	-
Rapeseed meal (36%), solv.	36.0	2.12	80	1.70	0.67	84	0.56	0.54	77	0.42	1.60	73	1.17	0.46	80	0.37	2.04	87	1.77	1.41	79	1.11	1.81	79	1.43
Rice	7.3	0.24	80	0.19	0.14	87	0.12	0.08	84	0.07	0.27	81	0.22	0.12	86	0.10	0.59	91	0.54	0.33	85	0.28	0.46	85	0.39
Rice bran	13.5	0.50	74	0.37	0.17	77	0.13	0.10	68	0.07	0.40	69	0.28	0.10	79	0.08	0.45	86	0.39	0.39	75	0.29	0.60	75	0.45
Rye	12.6	0.40	80	0.32	0.16	79	0.13	0.20	84	0.17	0.36	78	0.28	0.14	81	0.11	0.50	84	0.42	0.53	81	0.43	0.62	81	0.50
Safflower meal (20%), exp.	20.0	0.70	82	0.57	0.40	85	0.34	0.50	77	0.39	0.47	73	0.34	0.30	79	0.24	1.20	84	1.01	0.28	80	0.22	1.00	81	0.81
Safflower meal (22%), solv.	22.0	0.70	82	0.57	0.33	85	0.28	0.35	77	0.27	0.50	73	0.37	0.26	79	0.21	1.90	84	1.60	0.27	80	0.22	1.00	81	0.81
Sesame meal (42%), exp.	42.0	1.37	82	1.12	1.48	84	1.24	0.60	84	0.50	1.71	79	1.35	0.82	84	0.69	5.06	84	4.25	2.28	87	1.98	2.53	88	2.23
Sorghum, milo	11.0	0.27	90	0.24	0.10	89	0.09	0.20	79	0.16	0.27	83	0.22	0.09	87	0.08	0.40	88	0.35	0.60	90	0.54	0.53	87	0.46
Soybean meal (42%), exp.	42.0	2.70	91	2.45	0.60	91	0.54	0.62	82	0.51	1.70	84	1.43	0.58	88	0.51	3.20	91	2.92	2.80	91	2.55	2.20	89	1.96
Soybean meal (44%), solv.	44.0	2.90	90	2.61	0.65	91	0.59	0.67	82	0.55	1.70	85	1.45	0.60	89	0.53	3.40	93	3.16	2.50	89	2.23	2.40	88	2.11
Soybean meal (48%), solv.	47.8	3.02	90	2.72	0.70	91	0.64	0.71	82	0.58	2.00	85	1.70	0.70	89	0.62	3.60	93	3.35	2.60	89	2.31	2.70	88	2.38
Soybeans, full-fat, cooked	38.0	2.40	87	2.09	0.54	88	0.48	0.55	79	0.43	1.69	82	1.39	0.52	86	0.45	2.80	90	2.52	2.18	86	1.87	2.02	85	1.72
Sunflower meal (41%), exp.	41.0	2.00	87	1.74	1.60	92	1.47	0.80	80	0.64	1.60	82	1.31	0.60	87	0.52	4.20	83	3.49	2.40	89	2.14	2.40	87	2.09
Sunflower meal (42%), solv.	42.0	1.70	87	1.48	1.50	92	1.38	0.70	80	0.56	1.50	82	1.23	0.50	87	0.44	3.50	93	3.26	2.10	89	1.87	2.30	87	2.00
Wheat bran	14.8	0.60	73	0.44	0.20	80	0.16	0.30	74	0.22	0.48	74	0.36	0.30	82	0.25	1.07	82	0.88	0.60	79	0.47	0.70	77	0.54
Wheat middlings	15.0	0.70	80	0.56	0.12	86	0.10	0.19	74	0.14	0.50	73	0.37	0.20	79	0.16	1.00	80	0.80	0.70	82	0.57	0.80	77	0.62
Wheat, hard	13.5	0.40	86	0.34	0.25	91	0.23	0.30	90	0.27	0.35	87	0.30	0.18	86	0.15	0.60	85	0.51	0.69	94	0.65	0.69	90	0.62
Wheat, soft	10.8	0.30	86	0.26	0.14	91	0.13	0.20	90	0.18	0.28	78	0.22	0.12	86	0.10	0.40	85	0.34	0.43	94	0.40	0.48	90	0.43

Nutrient recommendations (pages 23–26) are based on calculations using these nutrient values (source: Feedstuffs Magazine).

Amino acid digestibility is standardized (true) ileal digestibility (Source: Evonik-Degussa).



**A PUBLICATION OF
HY-LINE INTERNATIONAL
1755 West Lakes Parkway
West Des Moines, Iowa 50266 U.S.A.
Telephone: 515-225-6030
Fax: 515-225-6425
www.hyline.com**

Hy-Line is a brand name. Numbers and letters identify varieties.
©Registered Trademark of Hy-Line International, West Des Moines, Iowa U.S.A.
©Copyright 2009. Hy-Line International

(01/09) Printed in U.S.A.